

TYRE CATALOGUE

Passenger Car, SUV and Light Truck

TRAZANO



TOP 9
No. 9 of Top 75 Global Tyre Manufacturers

SINCE 1958
Established in Year 1958

30,000 EMPLOYEES
Support from Over 30,000 Employees

200 MARKETS
Trust from Customers Across More than 200 Markets

Zhongce Rubber Group Co., Ltd (ZC-Rubber) is a global tyre company based in Hangzhou, China and was founded in 1958. Over our more than 60 years of history, we experienced continuous growth in quality and reputation to become the Top 10 tyre manufacturer worldwide today.

Our engineers with our international R&D team focus on constant technological development and innovation spending millions of US dollars in research and development each year and upgrading our production and testing facilities. The ET Industrial Brain in the production process promises our smart production and guarantee tyres with high quality, safety, and value with maximum efficiency.

We have formed an extensive global service network of about 1,200 distributors with 250,000 sales locations in 160 countries. Our subsidiaries in Thailand, Germany, Brazil, and the United States serve customers without any difference in time and language. We are dedicated to better support our suppliers, distributors, and customers through a one-stop service.

Safe and Value are always the key of our company. We take pride in the superior quality of our tyre products and the first-rate services. We are still endeavoring to become one of the most respected tyre manufacturers globally and craft a better future with all partners and friends.

Most Advanced Equipment

Best Raw Material

Leanest Management

Latest Technology

Least Energy Consumption

Most Suitable Products

COMPANY MISSION

WE ARE COMMITTED TO
ADVANCING TOWARDS
FUTURE MOBILITY

COMPANY VISION

TO BE A GLOBAL LEADING
TYRE MANUFACTURER



China Compulsory Certification



US DOT Certification



European E-MARK Certification



SNI Certification of Indonesia



BIS Certification of India



INMETRO Certification of Brazil



ZC-Rubber America Inc.



ZC-Rubber Mexico
(Under Construction)



ZC-Rubber Brasil Co. Ltd.



ZC-Rubber Europe Technical Center
ZC-Rubber Europe GmbH



ZC-Rubber Thailand Co. Ltd.



ZC-Rubber Indonesia
(Under Construction)



- ZC-Rubber Tianjin
- ZC-Rubber HQ
- ZC-Rubber Haichao
- ZC-Rubber Chaoyang
- ZC-Rubber Jiande
- ZC-Rubber Qingquan
- ZC-Rubber Yonggu
- ZC-Rubber Anji
- ZC-Rubber Jintan
- ZC-Rubber Recycling Tech. Co. Ltd.
- Hangzhou ZC-Rubber Auto Space Co. Ltd.

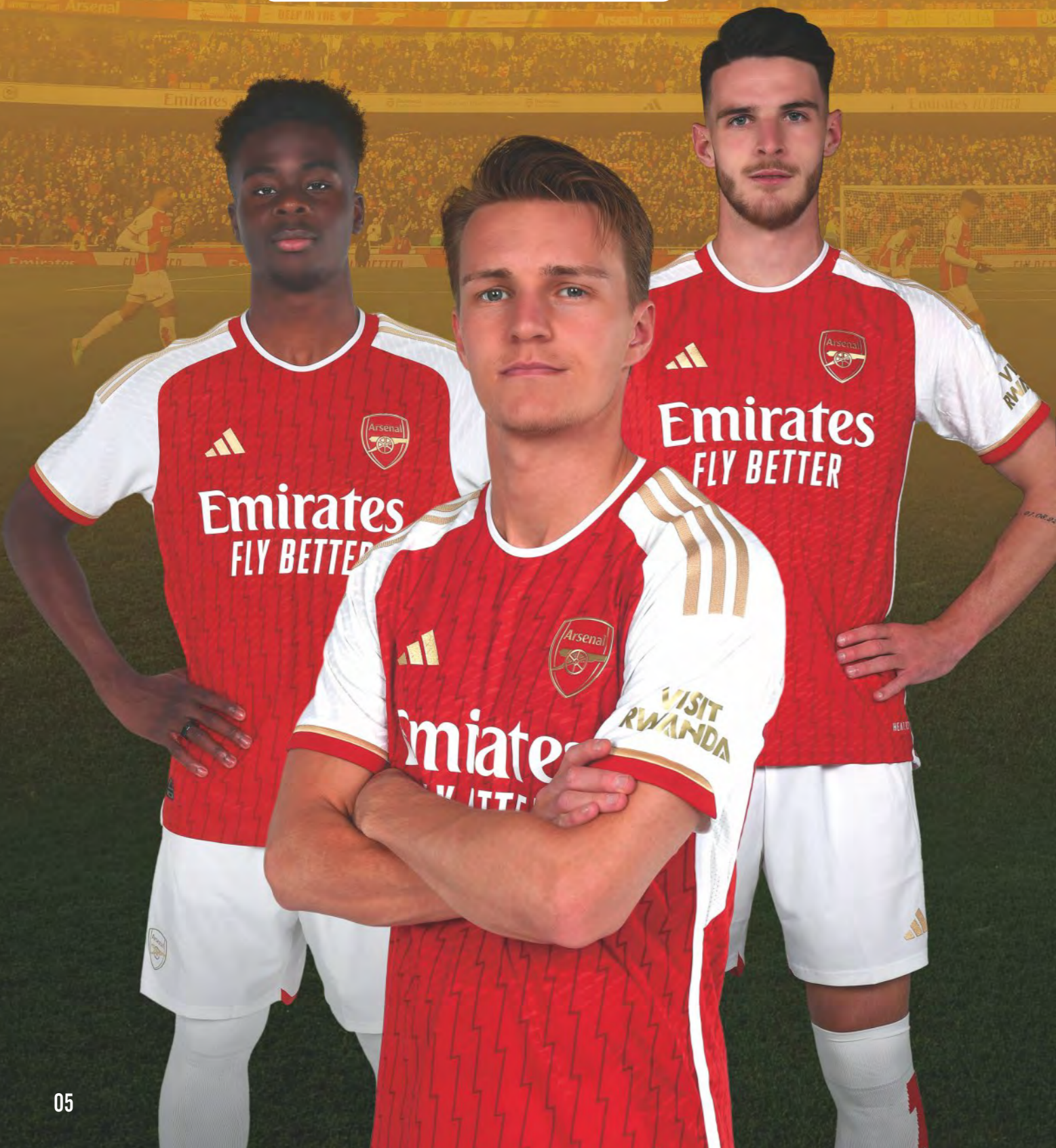

OE CUSTOMERS



KEY ACCOUNTS



KEY SUPPLIERS



TRAZANO CONTENTS

Passenger Car, SUV and Light Truck Tyres

ULTRA HIGH PERFORMANCE (UHP)

RS/RSII DSII T-017 (ZRT) T-017 SA-37 SA-57

09-20

PASSENGER

T-127 T-118 RP26

21-26

SUV / LTR

T-017 Z-203 SU320 SU318 SL369 SL399 SL339 SL366 SL376 SL378 SL315 SL309

27-50

COMMERCIAL LTR

SC328 SC326 H188 ST313

51-58

WINTER

Z-507 SW608 SW628 SW618 SW612 Z-506 SW606

59-72

TYRE KNOWLEDGE

73-79

SPORT RS



Benefits and Features

- Ideal drifting tyre with special design and components based on competition experiences
- Asymmetric tread design with big pattern blocks and special compound provides superior grip ability
- Continuous center rib generates better grip in dry conditions and enhances high-speed stability



Rim Size	15 - 20
Series	30 - 50
Speed Rating	V - W

SPORT RS

Rim (inch)	Size	Service Index	Standard Rim	Section Width (mm)	Overall Diameter (mm)	Max. Load (kg)	Max. Air Pressure (kPa)	UTQG	TT/TL	Rim (inch)	Size	Service Index	Standard Rim	Section Width (mm)	Overall Diameter (mm)	Max. Load (kg)	Max. Air Pressure (kPa)	UTQG	TT/TL
15"	195/50R15 RS	82V	6.0J	201	577	475	300	240	AA A TL	18"	285/35ZR18 XL RS II	101W	10.0J	290	657	825	350	180/240	AA A TL
	205/50R15 XL RS	89V	6.5J	214	587	580	350	240	AA A TL		225/40ZR18 XL RS	92W	8.0J	230	637	630	350	240	AA A TL
16"	205/45ZR16 XL RS	87W	7.0J	206	590	545	350	240	AA A TL	18"	235/40ZR18 XL RS II	95W	8.5J	241	645	690	350	180/240	AA A TL
	225/50R16 XL RS	96W	7.0J	233	632	710	350	240	AA A TL		275/30ZR19 XL RS	96W	9.5J	278	649	710	350	240	AA A TL
17"	235/40ZR17 RS	90W	8.5J	241	620	600	300	240	AA A TL	19"	235/35ZR19 XL RS	91W	8.5J	241	647	615	350	240	AA A TL
	245/40ZR17 XL RS	95W	8.5J	248	628	690	350	240	AA A TL		285/35ZR19 XL RS	103W	10.0J	290	683	875	350	240	AA A TL
	215/45ZR17 RS	87W	7.0J	213	626	545	300	240	AA A TL	20"	275/35ZR20 XL RS II	102W	9.5J	278	700	850	350	180/240	AA A TL
	225/45ZR17 XL RS	94W	7.5J	225	634	670	350	240	AA A TL		285/35ZR20 XL RS II	104W	10.0J	290	708	900	350	180/240	AA A TL
18"	235/45ZR17 RS	94W	8.0J	236	644	670	300	240	AA A TL	20"	255/40ZR20 XL RS II	101W	9.0J	260	712	825	350	180/240	AA A TL
	265/35ZR18 XL RS II	97W	9.5J	271	643	730	350	180/240	AA A TL										

• Made in China



SPORT DS II



Benefits and Features

- Ideal drifting tyre with special design and components based on competition experiences
- Directional pattern design provides outstanding handling and superior grip ability
- Continuous center rib generates better grip in dry conditions and enhances high-speed stability

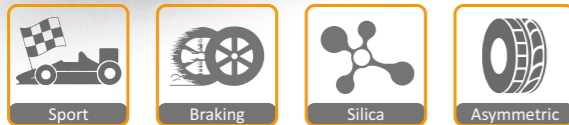

Rim Size	17 - 18
Series	35 - 45
Speed Rating	W

SPORT DS II

Rim (inch)	Size	Service Index	Standard Rim	Section Width (mm)	Overall Diameter (mm)	Max. Load (kg)	Max. Air Pressure (kpa)	UTQG	TT/TL	Rim (inch)	Size	Service Index	Standard Rim	Section Width (mm)	Overall Diameter (mm)	Max. Load (kg)	Max. Air Pressure (kpa)	UTQG	TT/TL
17"	• 245/40ZR17 XL	95W	8.5J	248	628	690	350	180 AA A	TL	18"	• 255/35ZR18 XL	94W	9.0J	260	635	670	350	180 AA A	TL
	• 255/40ZR17 XL	98W	9.0J	260	636	750	350	180 AA A	TL		• 265/35ZR18 XL	97W	9.5J	271	643	730	350	180 AA A	TL
	• 225/45ZR17 XL	94W	7.5J	225	634	670	350	180 AA A	TL		• 235/40ZR18 XL	95W	8.5J	241	645	690	350	180 AA A	TL

• Made in China



TALOS T-017 **ZRT**



Benefits and Features

ZC Rubber RunFlat Tyres (**ZRT**)

ADVANCED CARCASS STRUCTURE

Enhance the tyre body and avoid possible tyre failure during low pressure driving

SPECIAL REINFORCED SIDEWALL CONSTRUCTION

Supporting the tyres even if the air pressure dropped to zero

ZC Rubber first generation RunFlat tyres with extraordinary performance in low air pressure situation

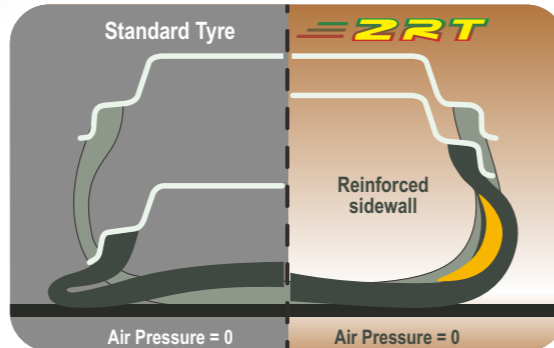

Hybrid Silane
(Driving Comfort)



Hybrid Formula
(Strong Grip)



BPOT Technology
(Improved Durability)

TALOS T-017 **ZRT**

Rim (inch)	Size	Service Index	Standard Rim	Section Width (mm)	Overall Diameter (mm)	Max. Load (kg)	Max. Air Pressure (kPa)	UTQG	TT/TL
17"	205/45R17 XL	88W	7.0J	206	616	560	350	320 AA A	TL
	225/45R17 XL	94W	7.5J	225	634	670	350	320 AA A	TL
	255/45R17 XL	102W	8.5J	255	662	850	350	320 AA A	TL
	205/50R17 XL	93W	6.5J	214	638	650	350	320 AA A	TL
	225/50R17 XL	98W	7.0J	233	658	750	350	320 AA A	TL
	205/55R17 XL	95W	6.5J	214	658	690	350	320 AA A	TL
18"	225/55R17 XL	101W	7.0J	233	680	825	350	320 AA A	TL
	255/35R18 XL	94W	9.0J	260	635	670	350	320 AA A	TL
	225/40R18 XL	92W	8.0J	230	637	630	350	320 AA A	TL
	235/40R18	91W	8.5J	241	645	615	300	320 AA A	TL
	245/40R18 XL	97W	8.5J	248	653	730	350	320 AA A	TL
	255/40R18 XL	99W	9.0J	260	661	775	350	320 AA A	TL
19"	275/40R18 XL	103W	9.5J	278	677	875	350	320 AA A	TL
	225/45R18 XL	95W	7.5J	225	659	690	350	320 AA A	TL
	245/45R18 XL	100W	8.0J	243	677	800	350	320 AA A	TL
	255/45R18 XL	103W	8.5J	255	687	875	350	320 AA A	TL
	225/50R18 XL	99W	7.0J	233	683	775	350	320 AA A	TL
	235/50R18 XL	101V	7.5J	245	693	825	350	320 AA A	TL
20"	245/50R18 XL	104W	7.5J	253	703	900	350	320 AA A	TL
	235/55R18 XL	104V	7.5J	245	715	900	350	320 AA A	TL
	255/55R18 XL	109W	8.0J	265	737	1030	350	320 AA A	TL
	285/30R19 XL	98W	10.0J	290	655	750	350	320 AA A	TL
	245/35R19 XL	93W	8.5J	248	655	650	350	320 AA A	TL
	255/35R19 XL	96W	9.0J	260	661	710	350	320 AA A	TL
21"	275/35R19 XL	100W	9.5J	278	675	800	350	320 AA A	TL
	225/40R19 XL	93W	8.0J	230	663	650	350	320 AA A	TL
	245/40R19 XL	98W	8.5J	248	679	750	350	320 AA A	TL
	255/40R19 XL	100W	9.0J	260	687	800	350	320 AA A	TL
	275/40R19	101W	9.5J	278	703	825	300	320 AA A	TL
	225/45R19 XL	96W	7.5J	225	685	710	350	320 AA A	TL
22"	285/45R19 XL	105W	10.0J	290	733	925	350	320 AA A	TL
	315/35R21 XL	111W	11.0J	320	753	1090	350	320 AA A	TL
	245/40R21 XL	100W	8.5J	248	729	800	350	320 AA A	TL
	275/40R21 XL	107W	9.5J	278	753	975	350	320 AA A	TL
	285/45R21 XL	113W	9.5J	285	789	1150	350	320 AA A	TL
	315/30R22 XL	107W	11.0J	320	749	975	350	320 AA A	TL
22"	275/35R22 XL	104W	9.5J	278	751	900	350	320 AA A	TL
	315/35R22 XL	111W	11.0J	320	779	1090	350	320 AA A	TL
	275/40R22 XL	107W	9.5J	278	779	975	350	320 AA A	TL

Made in China



Rim Size	17 - 22
Series	30 - 55
Speed Rating	V - W

TALOS T-017



Benefits and Features

Variable-pitch noise-reduction pattern blocks, sound-bolts in 4 circumferential grooves, and the staggered arrangement of inner and outer lateral grooves to provide consumers with a more comfortable driving experience

Hybrid Silane patent to optimize the tread compound and absorb road vibration effectively to further improved consumer's driving and experience

The patented Nanometer Mixing-Technology and High saturation pattern design, provide tyres with better wear resistance and increased mileage



Driving Comfort

Hybrid Silane™ to optimize tread rubber compound Soft Tread Compound and Minimized Vibration



Strong Grip

Hybrid Formula™ - Super hybrid rubber compound Fast water drainage and strong grip



Improved Durability

Nanometer Mixing-Technology™ for longer mileage



Hybrid Silane
(Driving Comfort)



Hybrid Formula
(Strong Grip)



BPOT Technology
(Improved Durability)

Rim Size 17 - 23

Series 30 - 55

Speed Rating V - Y

TALOS T-017

Rim (inch)	Size	Service Index	Standard Rim	Section Width (mm)	Overall Diameter (mm)	Max. Load (kg)	Max. Air Pressure (kPa)	UTQG	TT/TL	
17"	215/45ZR17 XL	91Y	7.0J	213	626	615	350	360 A A	TL	
	225/45ZR17 XL	94Y	7.5J	225	634	670	350	360 A A	TL	
	235/45ZR17 XL	97Y	8.0J	236	644	730	350	360 A A	TL	
	245/45ZR17 XL	99Y	8.0J	243	652	775	350	360 A A	TL	
	255/45ZR17	98Y	8.5J	255	662	750	300	360 A A	TL	
	205/50R17 XL	93W	6.5J	214	638	650	350	360 A A	TL	
	215/50R17	91W	7.0J	226	648	615	300	360 A A	TL	
	225/50R17 XL	98W	7.0J	233	658	750	350	360 A A	TL	
	235/50R17	96W	7.5J	245	668	710	300	360 A A	TL	
	215/55R17 XL	98W	7.0J	226	668	750	350	360 A A	TL	
	225/55R17 XL	101W	7.0J	233	680	825	350	360 A A	TL	
	235/55R17 XL	103W	7.5J	245	690	875	350	360 A A	TL	
	18"	255/35ZR18 XL	94Y	9.0J	260	635	670	350	360 A A	TL
		225/40ZR18 XL	92Y	8.0J	230	637	630	350	360 A A	TL
		235/40ZR18 XL	95Y	8.5J	241	645	690	350	360 A A	TL
245/40ZR18 XL		97Y	8.5J	248	653	730	350	360 A A	TL	
255/40ZR18 XL		99Y	9.0J	260	661	775	350	360 A A	TL	
265/40ZR18 XL		101Y	9.5J	271	669	825	350	360 A A	TL	
225/45ZR18 XL		95Y	7.5J	225	659	690	350	360 A A	TL	
235/45ZR18 XL EV		98Y	8.0J	236	669	750	350	360 A A	TL	
245/45ZR18 XL		100Y	8.0J	243	677	800	350	360 A A	TL	
255/45ZR18		99Y	8.5J	255	687	775	300	360 A A	TL	
265/45ZR18		101Y	9.0J	266	695	825	300	360 A A	TL	
275/45ZR18 XL		107Y	9.0J	273	705	975	350	360 A A	TL	
215/50R18		92W	7.0J	226	673	630	300	360 A A	TL	
225/50R18		95W	7.0J	233	683	690	300	360 A A	TL	
235/50R18 XL		101W	7.5J	245	693	825	350	360 A A	TL	
245/50R18	100W	7.5J	253	703	800	300	360 A A	TL		
215/55R18 XL EV	99V	7.0J	226	693	775	350	360 A A	TL		
225/55R18 XL EV	102W	7.0J	233	705	850	350	360 A A	TL		
235/55R18 EV	100W	7.5J	245	715	800	300	360 A A	TL		
255/55R18 XL	109W	8.0J	265	737	1030	350	360 A A	TL		
19"	255/30ZR19 XL	91Y	9.0J	260	637	615	350	360 A A	TL	
	235/35ZR19 XL	91Y	8.5J	241	647	615	350	360 A A	TL	
	245/35ZR19 XL	93Y	8.5J	248	655	650	350	360 A A	TL	
	255/35ZR19 XL	96Y	9.0J	260	661	710	350	360 A A	TL	
	275/35ZR19 XL	100Y	9.5J	278	675	800	350	360 A A	TL	
	225/40ZR19 XL	93Y	8.0J	230	663	650	350	360 A A	TL	
	235/40ZR19 XL	96Y	8.5J	241	671	710	350	360 A A	TL	
	245/40ZR19 XL	98Y	8.5J	248	679	750	350	360 A A	TL	
	255/40ZR19 XL	100Y	9.0J	260	687	800	350	360 A A	TL	
	265/40ZR19	98Y	9.5J	271	695	750	300	360 A A	TL	
	275/40ZR19 XL	105Y	9.5J	278	703	925	350	360 A A	TL	
	285/40ZR19 XL	107Y	10.0J	290	711	975	350	360 A A	TL	
	295/40ZR19 XL	108Y	10.5J	301	719	1000	350	360 A A	TL	
	225/45ZR19 XL	96Y	7.5J	225	685	710	350	360 A A	TL	
	235/45ZR19 XL	99Y	8.0J	236	695	775	350	360 A A	TL	
245/45ZR19 EV	98Y	8.0J	243	703	750	300	360 A A	TL		
255/45ZR19 XL EV	104Y	8.5J	255	713	900	350	360 A A	TL		
265/45ZR19 XL	105Y	9.0J	266	721	925	350	360 A A	TL		
275/45ZR19 XL EV	108Y	9.0J	273	731	1000	350	360 A A	TL		
235/50R19	99W	7.5J	245	719	775	300	360 A A	TL		
245/50R19 XL	105W	7.5J	253	729	925	350	360 A A	TL		
255/50R19 XL EV	107W	8.0J	265	739	975	350	360 A A	TL		
225/55R19 EV	99W	7.0J	233	731	775	300	360 A A	TL		
235/55R19 XL EV	105W	7.5J	245	741	925	350	360 A A	TL		
245/55R19	103V	7.5J	253	753	875	300	360 A A	TL		
255/55R19 XL	111W	8.0J	265	763	1090	350	360 A A	TL		
20"	295/35ZR20 XL	105Y	10.5J	301	714	925	350	360 A A	TL	
	255/30ZR20 XL	92Y	9.0J	260	662	630	350	360 A A	TL	
	265/30ZR20 XL	94Y	9.5J	271	668	670	350	360 A A	TL	
	275/30ZR20 XL	97Y	9.5J	278	674	730	350	360 A A	TL	
	235/35ZR20 XL EV	92Y	8.5J	241	672	630	350	360 A A	TL	
	255/35ZR20 XL	97Y	9.0J	260	686	730	350	360 A A	TL	
	265/35ZR20 XL	99Y	9.5J	271	694	775	350	360 A A	TL	
	275/35ZR20 XL	102Y	9.5J	278	700	850	350	360 A A	TL	
	285/35ZR20 XL	104Y	10.0J	290	708	900	350	360 A A	TL	
	315/35ZR20 XL	110Y	11.0J	320	728	1060	350	360 A A	TL	
	245/40ZR20 XL	99Y	8.5J	248	704	775	350	360 A A	TL	
	255/40ZR20 XL EV	101Y	9.0J	260	712	825	350	360 A A	TL	
	265/40ZR20 XL	104Y	9.5J	271	720	900	350	360 A A	TL	
	275/40ZR20 XL	106Y	9.5J	278	728	950	350	360 A A	TL	
	285/40ZR20 XL EV	108Y	10.0J	290	736	1000	350	360 A A	TL	
295/40ZR20 XL	110Y	10.5J	301	744	1060	350	360 A A	TL		
305/40ZR20 XL	112Y	11.0J	313	752	1120	350	360 A A	TL		
235/45ZR20 XL	100Y	8.0J	236	720	800	350	360 A A	TL		
245/45ZR20 XL EV	103W	8.0J	243	728	875	350	360 A A	TL		
255/45ZR20 XL EV	105Y	8.5J	255	738	925	350	360 A A	TL		
265/45ZR20 XL	108Y	9.0J	266	746	1000	350	360 A A	TL		
275/45ZR20 XL	110Y	9.0J	273	756	1060	350	360 A A	TL		
285/45ZR20 EV	108Y	9.5J	285	764	1000	300	360 A A	TL		
235/50R20 EV	104W	7.5J	245	744	900	350	360 A A	TL		
245/50R20 EV	102W	7.5J	253	754	850	300	360 A A	TL		
255/50R20 XL EV	109W	8.0J	265	764	1030	350	360 A A	TL		
235/55R20 XL	105W	7.5J	245	766	925	350	360 A A	TL		
255/55R20 XL	110W	8.0J	265	788	1060	350	360 A A	TL		
21"	275/30ZR21 XL	98Y	9.5J	278	699	750	350	360 A A	TL	
	285/30ZR21 XL	100Y	10.0J	290	705	800	350	360 A A	TL	
	315/30ZR21 XL	105Y	11.0J	320	723	925	350	360 A A	TL	
	245/35ZR21 XL EV	96Y	8.5J	248	705	710	350	360 A A	TL	
	275/35ZR21 XL EV	103Y	9.5J	278	725	875	350	360 A A	TL	
	285/35ZR21 XL	105Y	10.0J	290	733	925	350	360 A A	TL	
	295/35ZR21 XL	107Y	10.5J	301	739	975	350	360 A A	TL	
	255/40ZR21 XL	102Y	9.0J	260	737	850	350	360 A A	TL	
	265/40ZR21 XL	105Y	9.5J	271	745	925	350	360 A A	TL	
	275/40ZR21 XL	107Y	9.5J	278	753	975	350	360 A A	TL	
	285/40ZR21 XL	109Y	10.0J	290	761	1030	350	360 A A	TL	
	295/40ZR21 XL EV	111Y	10.5J	301	769	1090	350	360 A A	TL	
	315/40ZR21	111Y	11.0J	320	785	1090	300	360 A A	TL	
	235/45ZR21 XL EV	101Y	8.0J	236	745	825	350	360 A A	TL	
	255/45ZR21 XL EV	106W	8.5J	255	763	950	350	360 A A	TL	
265/45ZR21 XL EV	108Y	9.0J	266	771	1000	350	360 A A	TL		
275/45ZR21 XL	110Y	9.0J	273	781	1060	350	360 A A	TL		
285/45ZR21 XL	113Y	9.5J	285	789	1150	350	360 A A	TL		
22"	285/35ZR22 XL EV	106Y	10.0J	290	759	950	350	360 A A	TL	
	325/35ZR22	110Y	11.5J	331	787	1060	300	360 A A	TL	
	265/40R22 XL	106V	9.5J	271	771	950	350	360 A A	TL	
	275/40R22 XL	107Y	9.5J	278	779	975	350	360 A A	TL	
	285/40R22 XL	110Y	10.0J	290	787	1060	350	360 A A	TL	
	325/40R22 XL	114Y	11.5J	331	819	1180	300	360 A A	TL	
	255/45ZR22 XL	107Y	8.5J	255	789	975	350	360 A A	TL	
	275/45ZR22 XL	112Y	9.0J	273	807	11				

SPORT SA-37



Benefits and Features

- New generation of asymmetric ultra high performance tyre for summer
- SILICA TECH compound helps to enhance wet grip providing shorter braking distance
- Strong center rib guarantees excellent handling on both wet and dry roads and on-center feel

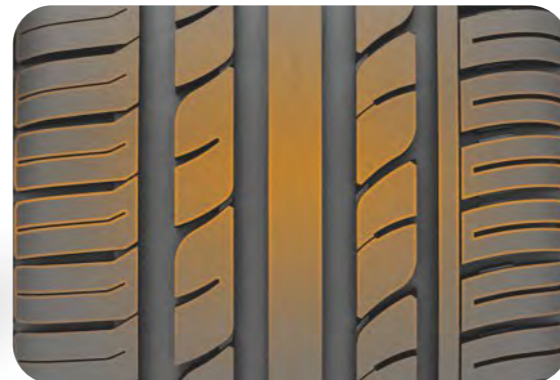

M+S

Rim Size	15 - 24
Series	30 - 65
Speed Rating	H - Y

SPORT SA-37

Rim (inch)	Size	Service Index	Standard Rim	Section Width (mm)	Overall Diameter (mm)	Max. Load (kg)	Max. Air Pressure (kPa)	UTQG	TT/TL	Rim (inch)	Size	Service Index	Standard Rim	Section Width (mm)	Overall Diameter (mm)	Max. Load (kg)	Max. Air Pressure (kPa)	UTQG	TT/TL	
15"	195/45R15	78V	6.5J	195	557	425	300	280 AA A	TL	18"	255/45Z18	99W	8.5J	255	687	775	300	280 AA A	TL	
	195/50R15	82V	6.0J	201	577	475	300	280 AA A	TL		225/50R18	95W	7.0J	233	683	690	300	280 AA A	TL	
	185/65R15	88H	5.5J	189	621	560	300	280 AA A	TL		235/50R18 XL	101V	7.5J	245	693	825	350	280 AA A	TL	
	195/65R15	91V	6.0J	201	635	615	300	280 AA A	TL		245/50R18	100W	7.5J	253	703	800	300	280 AA A	TL	
16"	195/45R16 XL	84V	6.5J	195	582	500	350	280 AA A	TL	215/55R18 XL	99V	7.0J	226	693	775	350	280 AA A	TL		
	205/45Z16 XL	87W	7.0J	206	590	545	350	280 AA A	TL	255/55R18 XL	109V	8.0J	265	737	1030	350	280 AA A	TL		
	195/50R16	84V	6.0J	201	602	500	300	280 AA A	TL	265/60R18	110V	8.0J	272	775	1060	300	280 AA A	TL		
	205/50R16	87W	6.5J	214	612	545	300	280 AA A	TL	19"	265/30Z19 XL	93Y	9.5J	271	643	650	350	280 AA A	TL	
	225/50R16	92W	7.0J	233	632	630	300	280 AA A	TL		275/30Z19 XL	96Y	9.5J	278	649	710	250	280 AA A	TL	
	205/55R16	91V	6.5J	214	632	615	300	280 AA A	TL		235/35Z19 XL	91Y	8.5J	241	647	615	350	280 AA A	TL	
	205/55R16 XL	94W	6.5J	214	632	670	350	280 AA A	TL		245/35Z19 XL	93Y	8.5J	248	655	650	350	280 AA A	TL	
	215/55R16	93V	7.0J	226	642	650	300	280 AA A	TL		255/35Z19 XL	96Y	9.0J	260	661	710	350	280 AA A	TL	
225/55R16 XL	99W	7.0J	233	654	775	350	280 AA A	TL	275/35Z19 XL		100W	9.5J	278	675	800	350	280 AA A	TL		
17"	185/35R17	74V	6.5J	188	562	375	350	280 AA A	TL		225/40Z19 XL	93Y	8.0J	230	663	650	350	280 AA A	TL	
	165/40R17 XL	72V	6.0J	170	564	355	300	280 AA A	TL		235/40Z19	96Y	8.5J	241	671	710	350	280 AA A	TL	
	195/40Z17 XL	81W	7.0J	200	588	462	350	280 AA A	TL	245/40Z19 XL	98Y	8.5J	248	679	750	350	280 AA A	TL		
	205/40Z17 XL	84Y	7.5J	212	596	500	350	280 AA A	TL	255/40Z19 XL	100Y	9.0J	260	687	800	350	280 AA A	TL		
	215/40Z17 XL	87Y	7.5J	218	604	545	350	280 AA A	TL	225/45Z19 XL	96Y	7.5J	225	685	710	350	280 AA A	TL		
	245/40Z17 XL	95Y	8.5J	248	628	690	350	280 AA A	TL	245/45Z19	98Y	8.0J	243	703	750	300	280 AA A	TL		
	205/45Z17 XL	88Y	7.0J	206	616	560	350	280 AA A	TL	255/45Z19 XL	104Y	8.5J	255	713	900	350	280 AA A	TL		
	215/45Z17 XL	91Y	7.0J	213	626	615	350	280 AA A	TL	235/50R19	99W	7.5J	245	719	775	300	280 AA A	TL		
	225/45Z17 XL	94Y	7.5J	225	634	670	350	280 AA A	TL	20"	225/30Z20 XL	85Y	8.0J	230	644	515	350	280 AA A	TL	
	235/45Z17 XL	97Y	8.0J	236	644	730	350	280 AA A	TL		275/30Z20 XL	97Y	9.5J	278	674	730	350	280 AA A	TL	
	245/45Z17 XL	99W	8.0J	243	652	775	350	280 AA A	TL		225/35Z20 XL	90W	8.0J	230	666	600	350	280 AA A	TL	
	255/45Z17 XL	102W	8.5J	255	662	850	350	280 AA A	TL		245/35Z20 XL	95Y	8.5J	248	680	690	350	280 AA A	TL	
	205/50R17 XL	93W	6.5J	214	638	650	350	280 AA A	TL		255/35Z20 XL	97W	9.0J	260	686	730	350	280 AA A	TL	
	215/50R17 XL	95W	7.0J	226	648	690	350	280 AA A	TL		275/35Z20 XL	102W	9.5J	278	700	850	350	280 AA A	TL	
	225/50R17 XL	98W	7.0J	233	658	750	350	280 AA A	TL		245/40Z20 XL	99W	8.5J	248	704	775	350	280 AA A	TL	
	235/50R17	96V	7.5J	245	668	710	300	280 AA A	TL		245/45Z20	99W	8.0J	243	728	775	300	280 AA A	TL	
205/55R17 XL	95W	6.5J	214	658	690	350	280 AA A	TL	255/45Z20 XL	105W	8.5J	255	748	925	350	280 AA A	TL			
215/55R17 XL	98W	7.0J	226	668	750	350	280 AA A	TL	265/45Z20 XL	108W	9.0J	266	746	1000	350	280 AA A	TL			
225/55R17 XL	101W	7.0J	233	680	825	350	280 AA A	TL	245/50R20	102W	7.5J	253	754	850	300	280 AA A	TL			
235/55R17 XL	103W	7.5J	245	690	875	350	280 AA A	TL	265/50R20 XL	111W	8.5J	277	774	1090	350	280 AA A	TL			
18"	165/35R18	69V	6.0J	170	573	325	350	280 AA A	TL	275/50R20 XL	113W	8.5J	284	784	1150	350	280 AA A	TL		
	215/35Z18 XL	84W	7.5J	218	607	500	350	280 AA A	TL	235/55R20 XL	105W	7.5J	245	766	925	350	280 AA A	TL		
	225/35Z18 XL	87Y	8.0J	230	615	545	350	280 AA A	TL	255/55R20 XL	110W	8.0J	265	788	1060	350	280 AA A	TL		
	245/35Z18 XL	92W	8.5J	248	629	630	350	280 AA A	TL	21"	295/35Z21 XL	107Y	10.5J	301	739	975	350	280 AA A	TL	
	265/35Z18 XL	97Y	9.5J	271	643	730	350	280 AA A	TL		265/40Z21 XL	105W	9.5J	271	745	925	350	280 AA A	TL	
	165/40R18	73V	6.0J	170	589	365	350	280 AA A	TL		295/40Z21	111W	10.5	301	769	1090	350	280 AA A	TL	
	215/40Z18 XL	89Y	7.5J	218	629	580	350	280 AA A	TL		315/40Z21	111Y	11.0J	320	785	1090	300	280 AA A	TL	
	225/40Z18 XL	92Y	8.0J	230	637	630	350	280 AA A	TL		265/45Z21	104W	9.0J	266	771	900	300	280 AA A	TL	
	235/40Z18 XL	95Y	8.5J	241	645	690	350	280 AA A	TL		275/45Z21 XL	110Y	9.0J	273	781	1060	350	280 AA A	TL	
	245/40Z18 XL	97Y	8.5J	248	653	730	350	280 AA A	TL		22"	235/30Z22 XL	90Y	8.5J	241	701	600	350	280 AA A	TL
	255/40Z18 XL	99Y	9.0J	260	661	775	350	280 AA A	TL			245/30Z22 XL	92Y	8.5J	248	707	630	350	280 AA A	TL
	215/45Z18 XL	93Y	7.0J	213	651	650	350	280 AA A	TL	285/45R22 XL		114V	9.5J	285	815	1180	350	280 AA A	TL	
	225/45Z18 XL	95Y	7.5J	225	659	690	350	280 AA A	TL	24"		275/25Z24 XL	96Y	10.0J	283	748	710	350	280 AA A	TL
	235/45Z18 XL	98Y	8.0J	236	669	750	350	280 AA A	TL		255/30Z24 XL	97Y	9.0J	260	764	730	350	280 AA A	TL	
	245/45Z18 XL	100Y	8.0J	243	677	800	350	280 AA A	TL											

• Made in China • Made in Thailand

ZUPERACE SA-57



Benefits and Features

- New generation of directional Ultra High Performance tyre
- Circumferential V-grooves ensure outstanding water drainage
- Strong center ribs provides remarkable handling while steering
- Improved SILICA compounding enhance the wet and dry grip



M+S

Rim Size	14 - 24
Series	30 - 65
Speed Rating	H - W

ZUPERACE SA-57

Rim (inch)	Size	Service Index	Standard Rim	Section Width (mm)	Overall Diameter (mm)	Max. Load (kg)	Max. Air Pressure (kpa)	UTQG	TT/TL	Rim (inch)	Size	Service Index	Standard Rim	Section Width (mm)	Overall Diameter (mm)	Max. Load (kg)	Max. Air Pressure (kpa)	UTQG	TT/TL
14"	185/60R14	82H	5.5J	189	578	475	300	460 A A	TL	18"	225/40ZR18 XL	92W	8.0J	230	637	630	350	460 A A	TL
	175/65R14	82H	5.0J	177	584	475	300	460 A A	TL		235/40ZR18 XL	95W	8.5J	241	645	690	350	460 A A	TL
	185/65R14	86H	5.5J	189	596	530	300	460 A A	TL		245/40ZR18 XL	97W	8.5J	248	653	730	350	460 A A	TL
15"	195/50R15	82V	6.0J	201	577	475	300	460 A A	TL	225/45ZR18 XL	95W	7.5J	225	659	690	350	460 A A	TL	
	185/55R15	82V	6.0J	194	585	475	300	460 A A	TL	235/45ZR18 XL	98W	8.0J	236	669	750	350	460 A A	TL	
	195/55R15	85V	6.0J	201	595	515	300	460 A A	TL	245/45ZR18 XL	100W	8.0J	243	677	800	350	460 A A	TL	
	185/60R15	84H	5.5J	189	603	500	300	460 A A	TL	225/50R18	95W	7.0J	233	683	690	300	460 A A	TL	
	195/60R15	88V	6.0J	201	615	560	300	460 A A	TL	235/50R18 XL	101W	7.5J	245	693	825	350	460 A A	TL	
	195/65R15	91V	6.0J	201	635	615	300	460 A A	TL	255/55R18 XL	109V	8.0J	265	737	1030	350	460 A A	TL	
16"	205/45ZR16 XL	87W	7.0J	206	590	545	350	460 A A	TL	265/60R18	110V	8.0J	272	775	1060	300	460 A A	TL	
	195/50R16	84V	6.0J	201	602	500	300	460 A A	TL	19"	215/35ZR19 XL	85W	7.5J	218	633	515	350	460 A A	TL
	205/50R16	87W	6.5J	214	612	545	300	460 A A	TL	225/35ZR19 XL	88W	8.0J	230	641	560	350	460 A A	TL	
	225/50R16	92W	7.0J	233	632	630	300	460 A A	TL	245/45ZR19 XL	102W	8.0J	243	703	850	350	460 A A	TL	
	205/55R16 XL	94W	6.5J	214	632	670	350	460 A A	TL	255/45ZR19 XL	104W	8.5J	255	713	900	350	460 A A	TL	
	215/55R16 XL	97W	7.0J	226	642	730	350	460 A A	TL	20"	205/30ZR20	80W	7.5J	212	632	450	350	460 A A	TL
	225/55R16 XL	99W	7.0J	233	654	775	350	460 A A	TL	215/30ZR20	82W	7.5J	218	638	475	350	460 A A	TL	
235/60R16	100H	7.0J	240	688	800	300	460 A A	TL	245/30ZR20 XL	90W	8.5J	248	656	600	350	460 A A	TL		
17"	205/40ZR17 XL	84W	7.5J	212	596	500	350	460 A A	TL	275/40ZR20 XL	106W	9.5J	278	728	950	350	460 A A	TL	
	215/40ZR17 XL	87W	7.5J	218	604	545	350	460 A A	TL	255/45R20 XL	105V	8.5J	255	738	925	350	460 A A	TL	
	245/40ZR17 XL	95W	8.5J	248	628	690	350	460 A A	TL	275/45R20 XL	110V	9.0J	273	756	1060	350	460 A A	TL	
	205/45ZR17 XL	88W	7.0J	206	616	560	350	460 A A	TL	265/50R20 XL	111V	8.5J	277	774	1090	350	460 A A	TL	
	215/45ZR17 XL	91W	7.0J	213	626	615	350	460 A A	TL	285/50R20	112V	9.0J	297	794	1120	300	460 A A	TL	
	225/45ZR17 XL	94W	7.5J	225	634	670	350	460 A A	TL	275/55R20 XL	117V	8.5J	284	810	1285	350	460 A A	TL	
	235/45ZR17 XL	97W	8.0J	236	644	730	350	460 A A	TL	275/60R20 XL	119V	8.0J	279	838	1360	350	460 A A	TL	
	205/50R17 XL	93W	6.5J	214	638	650	350	460 A A	TL	22"	265/35R22 XL	102V	9.5J	271	745	850	350	460 A A	TL
	215/50R17 XL	95W	7.0J	226	648	690	350	460 A A	TL	285/35R22 XL	106V	10.0J	290	759	950	350	460 A A	TL	
	225/50R17 XL	98W	7.0J	233	658	750	350	460 A A	TL	265/40R22 XL	106V	9.5J	271	771	950	350	460 A A	TL	
215/55R17 XL	98W	7.0J	226	668	750	350	460 A A	TL	305/40R22 XL	114V	11.0J	313	803	1180	350	460 A A	TL		
225/55R17 XL	101W	7.0J	233	680	825	350	460 A A	TL	305/45R22 XL	118V	10.0J	303	833	1320	350	460 A A	TL		
235/55R17 XL	103W	7.5J	245	690	875	350	460 A A	TL	24"	295/35R24 XL	110V	10.5J	301	816	1060	350	460 A A	TL	
18"	265/35ZR18 XL	97W	9.5J	271	643	730	350	460 A A	TL										

● Made in China ● Made in Thailand



TRITON T-127



Benefits and Features

- High-performance passenger tyre with superior handling and lower rolling resistance
- The rational siping design and uniform footprint pressure provide a more comfortable driving experience and higher mileage performance
- The variable pitch tread design helps minimize the impact on the road surface, resulting in a more comfortable ride
- The lateral groove with chamfer increases the friction force of the blocks, improving braking performance



TRITON T-127

Rim (inch)	Size	Service Index	Standard Rim	Section Width (mm)	Overall Diameter (mm)	Max. Load (kg)	Max. Air Pressure (kpa)	UTQG	TT/TL
13"	175/70R13	82T	5.0J	177	576	475	300	360 A A	TL
	165/80R13	83T	4.5J	165	594	487	300	360 A A	TL
14"	165/55R14	72V	5.0J	170	538	355	300	360 A A	TL
	185/60R14	82H	5.5J	189	578	475	300	360 A A	TL
	175/65R14	82H	5.0J	177	584	475	300	360 A A	TL
	185/65R14	86H	5.5J	189	596	530	300	360 A A	TL
	175/70R14	84T	5.0J	177	602	500	300	360 A A	TL
	185/70R14	88T	5.5J	189	616	560	300	360 A A	TL
15"	195/70R14	91T	6.0J	201	630	615	300	360 A A	TL
	165/50R15 XL	76V	5.0J	170	547	400	350	360 A A	TL
	195/50R15	82V	6.0J	201	577	475	300	360 A A	TL
	185/55R15	82V	6.0J	194	585	475	300	360 A A	TL
	195/55R15	85V	6.0J	201	595	515	300	360 A A	TL
	185/60R15	84H	5.5J	189	603	500	300	360 A A	TL
	195/60R15	88V	6.0J	201	615	560	300	360 A A	TL
	175/65R15	84H	5.0J	177	609	500	300	360 A A	TL
	185/65R15	88H	5.5J	189	621	560	300	360 A A	TL
	195/65R15	91H	6.0J	201	635	615	300	360 A A	TL
16"	205/65R15	94H	6.0J	209	647	670	300	360 A A	TL
	205/70R15	96H	6.0J	209	669	710	300	360 A A	TL
	215/70R15	98H	6.5J	221	683	750	300	360 A A	TL
	225/70R15	100H	6.5J	228	697	800	300	360 A A	TL
	205/45R16 XL	87W	7.0J	206	590	545	350	360 A A	TL
	195/50R16	84V	6.0J	201	602	500	300	360 A A	TL
	205/50R16	87V	6.5J	214	612	545	300	360 A A	TL
	185/55R16	83V	6.0J	194	610	487	300	360 A A	TL
	205/55R16 XL	94W	6.5J	214	632	670	350	360 A A	TL
	205/60R16	92V	6.0J	209	652	630	300	360 A A	TL
17"	215/60R16 XL	99V	6.5J	221	664	775	350	360 A A	TL
	225/60R16	98H	6.5J	228	676	750	300	360 A A	TL
	205/65R16	95H	6.0J	209	672	690	300	360 A A	TL
	215/65R16	98H	6.5J	221	686	750	300	360 A A	TL
	215/70R16	100H	6.5J	221	708	800	300	360 A A	TL
	225/70R16	103H	6.5J	228	722	875	300	360 A A	TL
	235/70R16	106H	7.0J	240	736	950	300	360 A A	TL
	245/70R16 XL	111H	7.0J	248	750	1090	350	360 A A	TL
	265/70R16	112H	8.0J	272	778	1120	300	360 A A	TL
	275/70R16	114H	8.0J	279	792	1180	300	360 A A	TL
18"	205/45R17 XL	88W	7.0J	206	616	560	350	360 A A	TL
	215/45R17 XL	91W	7.0J	213	626	615	350	360 A A	TL
	225/45R17 XL	94W	7.5J	225	634	670	350	360 A A	TL
	215/50R17 XL	95W	7.0J	226	648	690	350	360 A A	TL
	225/50R17 XL	98W	7.0J	233	658	750	350	360 A A	TL
	215/55R17 XL	98W	7.0J	226	668	750	350	360 A A	TL
	225/55R17 XL	101W	7.0J	233	680	825	350	360 A A	TL
	215/60R17	96V	6.5J	221	690	710	300	360 A A	TL
	225/60R17	99H	6.5J	228	702	775	300	360 A A	TL
	225/65R17	102H	6.5J	228	724	850	300	360 A A	TL
19"	235/65R17 XL	108H	7.0J	240	738	1000	350	360 A A	TL
	245/65R17	107H	7.0J	248	750	975	300	360 A A	TL
	265/65R17	112H	8.0J	272	776	1120	300	360 A A	TL
	285/65R17	116H	8.5J	292	802	1250	300	360 A A	TL
	265/70R17	115H	8.0J	272	804	1215	300	360 A A	TL
	225/45R18 XL	95W	7.5J	225	659	690	350	360 A A	TL
	235/45R18 XL	98W	8.0J	236	669	750	350	360 A A	TL
	245/45R18 XL	100W	8.0J	243	677	800	350	360 A A	TL
	235/50R18 XL	101V	7.5J	245	683	825	350	360 A A	TL
	235/55R18	100V	7.0J	245	715	800	300	360 A A	TL
18"	235/60R18 XL	107V	7.0J	240	739	975	350	360 A A	TL
	245/60R18	105H	7.0J	248	751	925	300	360 A A	TL
	265/60R18	110V	8.0J	272	775	1060	300	360 A A	TL
	285/60R18	116H	8.5J	292	799	1250	300	360 A A	TL
	265/65R18	114H	8.0J	272	801	1180	300	360 A A	TL
	275/65R18	116H	8.0J	279	815	1250	300	360 A A	TL
	235/55R19 XL	105V	7.5J	245	741	925	350	360 A A	TL

Made in Thailand

Rim Size	13 - 19
Series	45 - 80
Speed Rating	T - W



TRITON T-118



Benefits and Features

- High comfort touring tyre with a quiet and smooth ride
- Improved tyre structure guarantees stable handling and cornering
- Five strong tread ribs enhanced steering precision and mileage
- Variable pitch tread design helps reduce noise

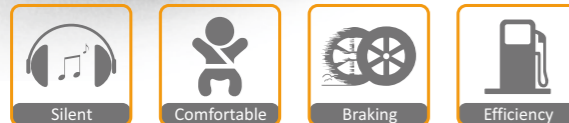
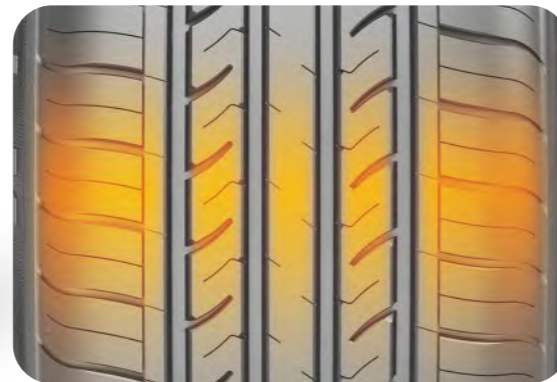

Rim Size	13 - 20
Series	35 - 80
Speed Rating	T - W

TRITON T-118

Rim (inch)	Size	Service Index	Standard Rim	Section Width (mm)	Overall Diameter (mm)	Max. Load (kg)	Max. Air Pressure (kpa)	UTQG	TT/TL
13"	155/65R13	73T	4.5J	157	532	365	300	480 A A	TL
	165/65R13	77T	5.0J	170	544	412	300	480 A A	TL
	155/70R13	75T	4.5J	157	548	387	300	480 A A	TL
	165/70R13	79T	5.0J	170	562	437	300	480 A A	TL
	175/70R13	82T	5.0J	177	576	475	300	480 A A	TL
	185/70R13	86T	5.5J	189	590	530	300	480 A A	TL
	175/75R13	85T	5.0J	177	592	515	300	480 A A	TL
	155/80R13	79T	4.5J	157	578	437	300	480 A A	TL
14"	165/55R14	72T	5.0J	170	538	355	300	480 A A	TL
	165/60R14	75H	5.0J	170	554	387	300	480 A A	TL
	185/60R14	82H	5.5J	189	578	475	300	480 A A	TL
	195/60R14	86H	6.0J	201	590	530	300	480 A A	TL
	205/60R14	88H	6.0J	209	602	560	300	480 A A	TL
	155/65R14	75T	4.5J	157	558	387	300	480 A A	TL
	165/65R14	79H	5.0J	170	570	437	300	480 A A	TL
	165/70R14	81T	5.0J	170	588	462	300	480 A A	TL
	205/70R14	95T	6.0J	209	644	690	300	480 A A	TL
	175/65R14	82H	5.0J	177	584	475	300	480 A A	TL
15"	185/65R14	86H	5.5J	189	596	530	300	480 A A	TL
	175/70R14	84T	5.0J	177	602	500	300	480 A A	TL
	185/70R14	88T	5.5J	189	616	560	300	480 A A	TL
	195/70R14	91T	6.0J	201	630	615	300	480 A A	TL
	175/75R14	87T	5.0J	177	618	545	300	480 A A	TL
	195/50R15	82V	6.0J	201	577	475	300	480 A A	TL
	165/55R15	75V	5.0J	170	563	387	300	480 A A	TL
	185/55R15	82V	6.0J	194	585	475	300	480 A A	TL
	195/55R15	85V	6.0J	201	595	515	300	480 A A	TL
	165/60R15	77H	5.0J	170	579	412	300	480 A A	TL
	185/60R15	84H	5.5J	189	603	500	300	480 A A	TL
	195/60R15	88V	6.0J	201	615	560	300	480 A A	TL
16"	205/60R15	91H	6.0J	209	627	615	300	480 A A	TL
	165/65R15	81H	5.0J	170	595	462	300	480 A A	TL
	175/65R15	84H	5.0J	177	609	500	300	480 A A	TL
	185/65R15	88H	5.5J	189	621	560	300	480 A A	TL
	195/65R15	91V	6.0J	201	635	615	300	480 A A	TL
	205/65R15	94V	6.0J	209	647	670	300	480 A A	TL
	205/70R15	96H	6.0J	209	669	710	300	480 A A	TL
	215/70R15	98H	6.5J	221	683	750	300	480 A A	TL
	195/50R16	84V	6.0J	201	602	500	300	480 A A	TL
	185/55R16	83V	6.0J	195	610	487	300	480 A A	TL
16"	195/55R16	87V	6.0J	201	620	545	300	480 A A	TL
	205/55R16	94W	6.5J	214	632	670	350	480 A A	TL
	215/55R16	93V	7.0J	226	642	650	300	480 A A	TL
	225/55R16	95V	7.0J	233	654	690	300	480 A A	TL
	195/60R16	89H	6.0J	201	640	580	300	480 A A	TL
	205/60R16	92V	6.0J	209	652	630	300	480 A A	TL
	215/60R16 XL	99V	6.5J	221	664	775	350	480 A A	TL
	225/60R16	98H	6.5J	228	676	750	300	480 A A	TL
	235/60R16	100H	7.0J	240	688	800	300	480 A A	TL
	205/65R16	95H	6.0J	209	672	690	300	480 A A	TL
	215/65R16	98V	6.5J	221	686	750	300	480 A A	TL
	17"	205/40R17 XL	84W	7.5J	212	596	500	350	480 A A
215/40R17XL		87W	7.5J	218	604	545	350	480 A A	TL
205/45R17 XL		88W	7.0J	206	616	560	350	480 A A	TL
215/45R17 XL		91W	7.0J	213	626	615	350	480 A A	TL
225/45R17 XL		94W	7.5J	225	634	670	350	480 A A	TL
235/45R17 XL		97W	8.0J	236	644	730	350	480 A A	TL
205/50R17 XL		93W	6.5J	214	638	650	350	480 A A	TL
215/50R17XL		95W	7.0J	226	648	690	350	480 A A	TL
225/50R17 XL		98W	7.0J	233	658	750	350	480 A A	TL
215/55R17 XL		98W	7.0J	226	668	750	350	480 A A	TL
225/55R17 XL		101W	7.0J	233	680	825	350	480 A A	TL
235/55R17 XL		103W	7.5J	245	690	875	350	480 A A	TL
18"	225/40R18	92W	8.0J	230	637	630	350	480 A A	TL
	235/40R18	95W	8.5J	241	645	690	350	480 A A	TL
	245/40R18	97W	8.5J	248	653	730	350	480 A A	TL
	215/45R18	93W	7.0J	213	651	650	350	480 A A	TL
	225/45R18	95W	7.5J	225	659	690	350	480 A A	TL
	235/45R18	98W	8.0J	236	669	750	350	480 A A	TL
	245/45R18	100W	8.0J	243	677	800	350	480 A A	TL
	225/50R18	95W	7.0J	233	683	690	300	480 A A	TL
	235/50R18	97V	7.5J	245	693	730	300	480 A A	TL
	215/55R18	99V	7.0J	226	693	775	350	480 A A	TL
	225/55R18	98V	7.0J	233	705	750	300	480 A A	TL
	235/55R18	100V	7.5J	245	715	800	300	480 A A	TL
19"	225/60R18	100H	6.5J	228	727	800	300	480 A A	TL
	235/60R18	107V	7.0J	240	739	975	350	480 A A	TL
	245/35R19	93W	8.5J	248	655	650	350	480 A A	TL
	245/40R19	94W	8.5J	248	679	670	300	480 A A	TL
20"	245/35R20 XL	95W	8.5J	248	680	690	350	480 A A	TL

Made in China



RP26



Benefits and Features

- Improved tyre structure compared to competitor for longer tyre life and more comfort ride
- Special compound offers remarkable tyre traction

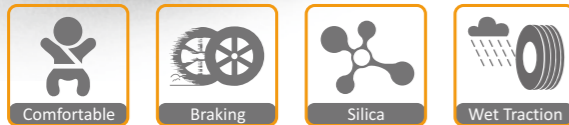
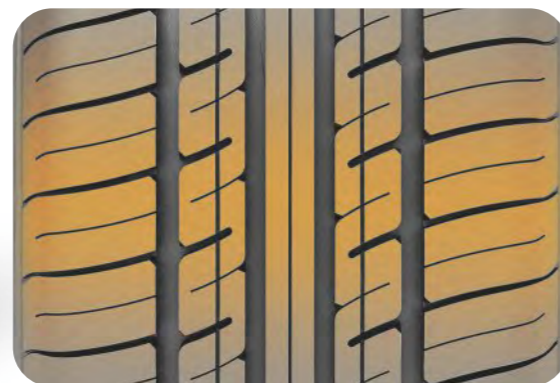

M+S

Rim Size	13 - 16
Series	50 - 80
Speed Rating	T - V

RP26

Rim (inch)	Size	Service Index	Standard Rim	Section Width (mm)	Overall Diameter (mm)	Max. Load (kg)	Max. Air Pressure (kpa)	UTQG	TT/TL	Rim (inch)	Size	Service Index	Standard Rim	Section Width (mm)	Overall Diameter (mm)	Max. Load (kg)	Max. Air Pressure (kpa)	UTQG	TT/TL
13"	175/60R13	77H	5.0J	177	540	412	300	440 A A	TL	15"	195/55R15	85V	6.0J	201	595	515	300	360 A A	TL
	205/60R13	86T	6.0J	209	576	530	300	480 A A	TL		205/55R15	88V	6.5J	214	607	560	300	360 A A	TL
	155/65R13	73T	4.5B	157	532	365	300	440 A A	TL		175/60R15	81H	5.0J	177	591	462	300	440 A A	TL
	165/65R13	77T	5.0B	170	544	412	300	440 A A	TL		185/60R15	84H	5.5J	189	603	500	300	480 A A	TL
	165/70R13	79T	5.0B	170	562	437	300	440 A A	TL		195/60R15	88H	6.0J	201	615	560	300	480 A A	TL
	175/70R13	82T	5.0B	177	576	475	300	440 A A	TL		205/60R15	91H	6.0J	209	627	615	300	480 A A	TL
	185/70R13	86T	5.5J	189	590	530	300	480 A A	TL		215/60R15	94H	6.5J	221	639	670	300	480 A A	TL
	155/80R13	79T	4.5B	157	578	437	300	440 A A	TL		175/65R15	84H	5.0J	177	609	500	300	440 A A	TL
	165/80R13	83T	4.5B	165	594	487	300	440 A A	TL		185/65R15	88H	5.5J	189	621	560	300	480 A A	TL
	14"	175/60R14	79H	5.0J	177	566	437	300	440 A A		TL	195/65R15	91H	6.0J	201	635	615	300	480 A A
185/60R14		82H	5.5J	189	578	475	300	480 A A	TL	205/65R15	94H	6.0J	209	647	670	300	480 A A	TL	
195/60R14		86H	6.0J	201	590	530	300	480 A A	TL	215/65R15	96H	6.5J	221	661	710	300	480 A A	TL	
155/65R14		75T	4.5B	157	558	387	300	440 A A	TL	205/70R15	96H	6.0J	209	669	710	300	480 A A	TL	
175/65R14		82H	5.0J	177	584	475	300	440 A A	TL	215/70R15	98H	6.5J	221	683	750	300	480 A A	TL	
185/65R14		86H	5.5J	189	596	530	300	480 A A	TL	16"	195/50R16	84V	6.0J	201	602	500	300	360 A A	TL
165/70R14		81T	5.0J	170	588	462	300	440 A A	TL		185/55R16	83V	6.0J	194	610	487	300	360 A A	TL
175/70R14		84T	5.0J	177	602	500	300	440 A A	TL		195/55R16 XL	91V	6.0J	201	620	615	350	360 A A	TL
185/70R14		88T	5.5J	189	616	560	300	480 A A	TL		205/55R16	91V	6.5J	214	632	615	300	360 A A	TL
195/70R14		91T	6.0J	201	630	615	300	480 A A	TL		195/60R16	89H	6.0J	201	640	580	300	480 A A	TL
205/70R14	95T	6.0J	209	644	690	300	480 A A	TL	205/60R16		92H	6.0J	209	652	630	300	480 A A	TL	
175/80R14	88T	5.0J	177	636	560	300	440 A A	TL	215/60R16		95H	6.5J	221	664	690	300	480 A A	TL	
185/80R14	91T	5.0J	184	652	615	300	480 A A	TL	225/60R16		98H	6.5J	228	676	750	300	480 A A	TL	
15"	175/50R15	75V	5.5J	182	557	387	300	440 A A	TL		235/60R16	100H	7.0J	240	688	800	300	480 A A	TL
	195/50R15	82V	6.0J	201	577	475	300	360 A A	TL		205/65R16	95H	6.0J	209	672	690	300	480 A A	TL
	175/55R15	77T	5.5J	182	573	412	300	440 A A	TL	215/65R16	98H	6.5J	221	686	750	300	480 A A	TL	
	185/55R15	82V	6.0J	194	585	475	300	360 A A	TL	225/65R16	100H	6.5J	228	698	800	300	480 A A	TL	

● Made in China ● Made in Thailand



TALOS T-017 SUV



Benefits and Features

Variable-pitch noise-reduction pattern blocks, sound-bolts in 4 circumferential grooves, and the staggered arrangement of inner and outer lateral grooves to provide consumers with a more comfortable driving experience.

Hybrid Silane patent to optimize the tread compound and absorb road vibration effectively to further improved consumer's driving and experience

The patented Nanometer Mixing-Technology and High saturation pattern design, provide tires with better wear resistance and increased mileage.

Improved Durability

Nanometer Mixing-Technology™ for longer mileage



Driving Comfort

Hybrid Silane™ to optimize tread rubber compound
Soft Tread Compound and Minimized Vibration

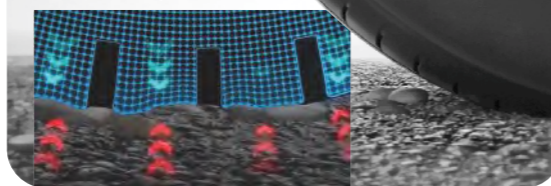

Strong Grip

Hybrid Formula™- Super hybrid rubber compound Fast water drainage and strong grip



3
BPOT Technology
(Improved Durability)

Hybrid Silane
(Driving Comfort)

Hybrid Formula
(Strong Grip)

M+S

Rim Size	17 - 22
Series	50 - 70
Speed Rating	T - V

TALOS T-017 SUV

Rim (inch)	Size	Service Index	Standard Rim	Section Width (mm)	Overall Diameter (mm)	Max. Load (kg)	Max. Air Pressure (kpa)	UTQG	TT/TL	Rim (inch)	Size	Service Index	Standard Rim	Section Width (mm)	Overall Diameter (mm)	Max. Load (kg)	Max. Air Pressure (kpa)	UTQG	TT/TL		
17"	215/60R17	96V	6.5J	221	690	710	300	500 A A	TL	18"	265/60R18 XL	114V	8.0J	272	775	1180	350	500 A A	TL		
	225/60R17 XL	103V	6.5J	228	702	875	350	500 A A	TL		285/60R18	116V	8.5J	292	799	1250	300	500 A A	TL		
	235/60R17	102V	7.0J	240	714	850	300	500 A A	TL		235/65R18 EV	106H	7.0J	240	763	950	300	500 A A	TL		
	255/60R17 XL	110V	7.5J	260	738	1060	350	500 A A	TL		265/65R18	114T	8.0J	272	801	1180	300	500 A A	TL		
	215/65R17 EV	99V	6.5J	221	712	775	300	500 A A	TL		19"	265/50R19 XL	110V	8.5J	277	749	1060	350	500 A A	TL	
	225/65R17 XL	106V	6.5J	228	724	950	350	500 A A	TL			275/50R19 XL	112V	8.5J	284	759	1120	350	500 A A	TL	
	235/65R17 XL	108V	7.0J	240	738	1000	350	500 A A	TL			275/55R19	111V	8.5J	284	785	1090	300	500 A A	TL	
	245/65R17	107H	7.0J	248	750	975	300	500 A A	TL			235/60R19 XL EV	107V	7.0J	240	765	975	350	500 A A	TL	
	265/65R17	112H	8.0J	272	776	1120	300	500 A A	TL			255/60R19 XL	113V	7.5J	260	789	1150	350	500 A A	TL	
	275/65R17	115H	8.0J	279	790	1215	300	500 A A	TL			235/65R19 XL	109V	7.0J	240	789	1030	350	500 A A	TL	
285/65R17	116H	8.5J	292	802	1250	300	500 A A	TL	20"	265/50R20 XL		111V	8.5J	277	774	1090	350	500 A A	TL		
215/70R17	101H	6.5J	221	734	825	300	500 A A	TL		285/50R20		112V	9.0J	297	794	1120	300	500 A A	TL		
18"	225/60R18	100H	6.5J	228	727	800	300	500 A A		TL		275/55R20 XL	117V	8.5J	284	810	1285	350	500 A A	TL	
	235/60R18 XL EV	107V	7.0J	240	739	975	350	500 A A		TL		21"	275/50R21 XL	113V	8.5J	284	809	1150	350	500 A A	TL
	245/60R18	105H	7.0J	248	751	925	300	500 A A		TL	22"		275/50R22	111H	8.5J	284	835	1090	300	500 A A	TL
	255/60R18 XL	112V	7.5J	260	763	1120	350	500 A A		TL											

● Made in China EV EV Ready



ZUPER TREK Z-203



Benefits and Features

- Optimized casing construction ensure a comfort ride
- Four straight tread grooves guarantee excellent water drainage
- Multi siping design provides outstanding traction on various road surface
- improved footprint promises less fuel consumption and remarkable tyre life

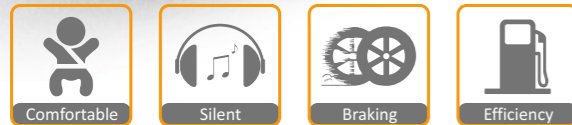
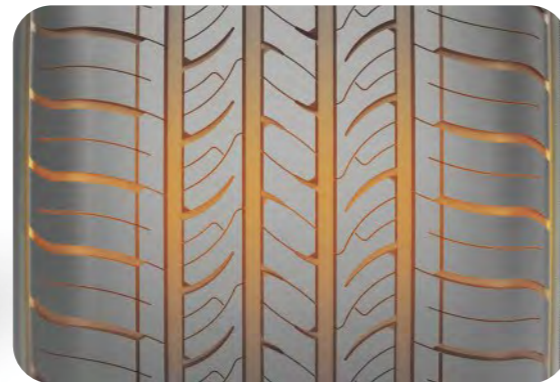

Rim Size	16 - 22
Series	35 - 70
Speed Rating	H - Y

ZUPER TREK Z-203

Rim (inch)	Size	Service Index	Standard Rim	Section Width (mm)	Overall Diameter (mm)	Max. Load (kg)	Max. Air Pressure (kpa)	UTQG	TT/TL	Rim (inch)	Size	Service Index	Standard Rim	Section Width (mm)	Overall Diameter (mm)	Max. Load (kg)	Max. Air Pressure (kpa)	UTQG	TT/TL
16"	215/70R16	100H	6.5J	221	708	800	300	400 A A	TL	18"	235/65R18	106H	7.0J	240	763	950	300	400 A A	TL
	225/70R16	103H	6.5J	228	722	875	300	400 A A	TL		265/65R18	114H	8.0J	272	801	1180	300	400 A A	TL
	235/70R16	106H	7.0J	240	736	950	300	400 A A	TL		275/65R18	116H	8.0J	279	815	1250	300	400 A A	TL
	245/70R16 XL	111H	7.0J	248	750	1090	350	400 A A	TL		255/70R18	113H	7.5J	260	815	1150	300	400 A A	TL
	265/70R16	112H	8.0J	272	778	1120	300	400 A A	TL		265/70R18	116H	8.0J	272	829	1250	300	400 A A	TL
	275/70R16	114H	8.0J	279	792	1180	300	400 A A	TL		19"	255/50R19 XL	107V	8.0J	265	739	975	350	400 A A
17"	225/60R17	99H	6.5J	228	702	775	300	400 A A	TL	235/55R19 XL		105V	7.5J	245	741	925	350	400 A A	TL
	235/65R17	102H	6.5J	228	724	850	300	400 A A	TL	255/55R19 XL		111V	8.0J	265	763	1090	350	400 A A	TL
	235/65R17 XL	108H	7.0J	240	738	1000	350	400 A A	TL	265/55R19	109V	8.5J	277	775	1030	300	400 A A	TL	
	245/65R17	107H	7.0J	248	750	975	300	400 A A	TL	20"	315/35R20 XL	110Y	11.0J	320	728	1060	350	400 A A	TL
	265/65R17	112H	8.0J	272	776	1120	300	400 A A	TL		275/40R20 XL	106Y	9.5J	278	728	950	350	400 A A	TL
	275/65R17	115H	8.0J	279	790	1215	300	400 A A	TL		255/50R20 XL	109V	8.0J	265	764	1030	350	400 A A	TL
18"	285/65R17	116H	8.5J	292	802	1250	300	400 A A	TL	265/50R20 XL	111V	8.5J	277	774	1090	350	400 A A	TL	
	245/70R17	110H	7.0J	248	776	1060	300	400 A A	TL	285/50R20	112H	9.0J	297	794	1120	300	400 A A	TL	
	265/70R17	115H	8.0J	272	804	1215	300	400 A A	TL	255/55R20 XL	110V	8.0J	265	788	1060	350	400 A A	TL	
	235/50R18	101V	7.5J	245	693	825	350	400 A A	TL	265/55R20 XL	113V	8.5J	277	800	1150	350	400 A A	TL	
	235/55R18	100H	7.5J	245	715	800	300	400 A A	TL	275/55R20 XL	117V	8.5J	284	810	1285	350	400 A A	TL	
	225/60R18	100H	6.5J	228	727	800	300	400 A A	TL	275/60R20	115H	8.0J	279	838	1215	300	400 A A	TL	
	235/60R18	103H	7.0J	240	739	875	300	400 A A	TL	21"	275/50R21 XL	113V	8.5J	284	809	1150	350	400 A A	TL
	245/60R18	105H	7.0J	248	751	925	300	400 A A	TL		22"	275/40R22	107W	9.5J	278	779	975	350	400 A A
	255/60R18	112V	7.5J	260	763	1120	350	400 A A	TL	285/45R22		110H	9.5J	285	815	1060	300	400 A A	TL
	265/60R18	110V	8.0J	272	775	1060	300	400 A A	TL	275/50R22		111H	8.5J	284	835	1090	300	400 A A	TL
285/60R18	116H	8.5J	292	799	1250	300	400 A A	TL											

● Made in China



CROSS LEGEND SU320



Benefits and Features

- High stiffness center rib provide precise steering
- Four straight main grooves efficiently resist hydroplaning & aquaplaning performance up
- Zig-Zag snow siping allows for improved all-season performance

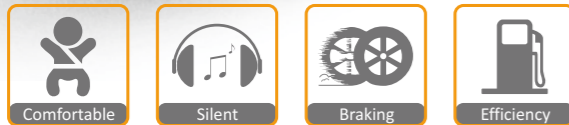
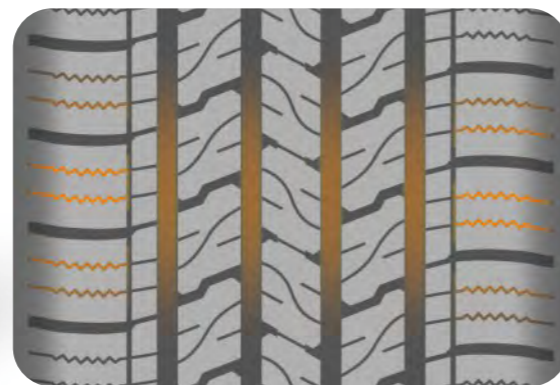

M+S

Rim Size	15 - 24
Series	35 - 75
Speed Rating	T - V

CROSS LEGEND SU320

Rim (inch)	Size	Service Index	Standard Rim	Section Width (mm)	Overall Diameter (mm)	Max. Load (kg)	Max. Air Pressure (kpa)	UTQG	TT/TL
15"	225/70R15	100T	6.5J	228	697	800	300	500 A A	TL
	235/70R15	103T	7.0J	240	711	875	300	500 A A	TL
	265/70R15	112T	8.0J	272	753	1120	300	500 A A	TL
	215/75R15	100T	6.0J	216	703	800	300	500 A A	TL
	225/75R15	102T	6.0J	223	719	850	300	500 A A	TL
	235/75R15	105H	6.5J	235	733	925	300	500 A A	TL
16"	265/75R15	112T	7.5J	267	779	1120	300	500 A A	TL
	255/65R16	109H	7.5J	260	738	1030	300	500 A A	TL
	205/70R16	97T	6.0J	209	704	730	300	500 A A	TL
	215/70R16	100T	6.5J	221	708	800	300	500 A A	TL
	225/70R16	103H	6.5J	228	722	875	300	500 A A	TL
	235/70R16	106H	7.0J	240	736	950	300	500 A A	TL
	245/70R16	107T	7.0J	248	750	975	300	500 A A	TL
	255/70R16	111H	7.5J	260	764	1090	300	500 A A	TL
	265/70R16	112T	8.0J	272	778	1120	300	500 A A	TL
	275/70R16	114T	8.0J	279	792	1180	300	500 A A	TL
	225/75R16	104H	6.0J	223	744	900	300	500 A A	TL
	235/75R16	108T	6.5J	235	758	1000	300	500 A A	TL
17"	245/75R16	111T	7.0J	248	774	1080	300	500 A A	TL
	265/75R16	116T	7.5J	267	804	1250	300	500 A A	TL
	215/60R17	96H	6.5J	221	690	710	300	500 A A	TL
	225/60R17	99T	6.5J	228	702	775	300	500 A A	TL
	235/60R17	102T	7.0J	240	714	850	300	500 A A	TL
	255/60R17 XL	110V	7.5J	260	738	1060	350	500 A A	TL
	265/60R17	108T	8.0J	272	750	1000	300	500 A A	TL
	275/60R17	110T	8.0J	279	762	1060	300	500 A A	TL
	215/65R17	99T	6.5J	221	712	775	300	500 A A	TL
	225/65R17	102H	6.5J	228	724	850	300	500 A A	TL
	235/65R17	104H	7.0J	240	738	900	300	500 A A	TL
	245/65R17	107T	7.0J	248	750	975	300	500 A A	TL
255/65R17	110H	7.5J	260	764	1060	300	500 A A	TL	
265/65R17	112H	8.0J	272	776	1120	300	500 A A	TL	
275/65R17	115T	8.0J	279	790	1215	300	500 A A	TL	
285/65R17	116H	8.5J	292	802	1250	300	500 A A	TL	
235/70R17	109T	7.0J	240	762	1030	300	500 A A	TL	
245/70R17	110T	7.0J	248	776	1060	300	500 A A	TL	
255/70R17	112T	7.5J	260	790	1120	300	500 A A	TL	
265/70R17	115H	8.0J	272	804	1215	300	500 A A	TL	
255/75R17	115S	7.0J	255	814	1215	300	500 A A	TL	
18"	225/50R18	95V	7.0J	233	683	690	300	500 A A	TL
	235/50R18	97V	7.5J	245	693	730	300	500 A A	TL
18"	215/55R18	95V	7.0J	226	693	690	300	500 A A	TL
	225/55R18	98V	7.0J	233	705	750	300	500 A A	TL
	235/55R18	100V	7.5J	245	715	800	300	500 A A	TL
	245/55R18	103V	7.5J	253	727	875	300	500 A A	TL
	255/55R18 XL	109V	8.0J	265	737	1030	350	500 A A	TL
	225/60R18	100H	6.5J	228	727	800	300	500 A A	TL
	235/60R18	103V	7.0J	240	739	875	300	500 A A	TL
	245/60R18	105T	7.0J	248	751	925	300	500 A A	TL
	255/60R18 XL	112V	7.5J	260	763	1120	350	500 A A	TL
	265/60R18 XL	114V	8.0J	272	775	1180	350	500 A A	TL
	285/60R18	116H	8.5J	292	799	1250	300	500 A A	TL
	225/65R18	103H	6.5J	228	749	875	300	500 A A	TL
235/65R18	106H	7.0J	240	763	950	300	500 A A	TL	
255/65R18	111T	7.5J	260	789	1090	300	500 A A	TL	
265/65R18	114T	8.0J	272	801	1180	300	500 A A	TL	
275/65R18	116T	8.0J	279	815	1250	300	500 A A	TL	
255/70R18	113T	7.5J	260	815	1150	300	500 A A	TL	
265/70R18	116H	8.0J	272	829	1250	300	500 A A	TL	
19"	275/45R19 XL	108V	9.0J	273	731	1000	350	500 A A	TL
	235/50R19	99V	7.5J	245	719	775	300	500 A A	TL
	255/50R19 XL	107V	8.0J	265	739	975	350	500 A A	TL
	225/55R19	99V	7.0J	233	731	775	300	500 A A	TL
	245/55R19	103V	7.5J	253	753	875	300	500 A A	TL
	255/55R19 XL	111V	8.0J	265	763	1090	350	500 A A	TL
255/60R19	109H	7.5J	260	789	1030	300	500 A A	TL	
20"	255/40R20	101V	9.0J	260	712	825	350	500 A A	TL
	275/40R20 XL	106V	9.5J	278	728	950	350	500 A A	TL
	275/45R20 XL	110V	9.0J	273	756	1060	350	500 A A	TL
	245/50R20	102V	7.5J	253	754	850	300	500 A A	TL
	255/50R20 XL	109V	8.0J	265	764	1030	350	500 A A	TL
	265/50R20 XL	111V	8.5J	277	774	1090	350	500 A A	TL
	285/50R20 XL	116H	9.0J	297	309	1250	350	500 A A	TL
	235/55R20	102H	7.5J	245	766	850	300	500 A A	TL
	255/55R20	107H	8.0J	265	788	975	300	500 A A	TL
	275/55R20 XL	117V	8.5J	284	810	1285	350	500 A A	TL
	275/60R20	115H	8.0J	279	838	1215	300	500 A A	TL
	22"	305/40R22 XL	114V	11.0J	313	803	1060	350	500 A A
285/45R22		114H	9.5J	285	815	1180	300	500 A A	TL
305/45R22 XL		118V	10.0J	303	833	1320	350	500 A A	TL
24"	305/35R24 XL	112V	11.0J	313	814	1120	350	500 A A	TL

Made in Thailand



SU318 H/T



Benefits and Features

- Ideal H/T tyre integrated outstanding on-road comfort and wet traction safety as a whole
- Four longitude grooves combined with wind sipes ensure excellent water evacuation and wet traction performance
- SILICA TECH adopted for better wet grip as well as low rolling resistance
- Re-constructed steel bead wire improves driving comfort effectively

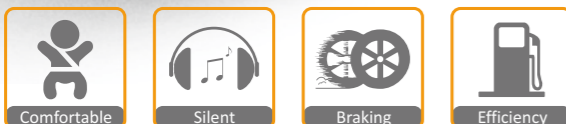
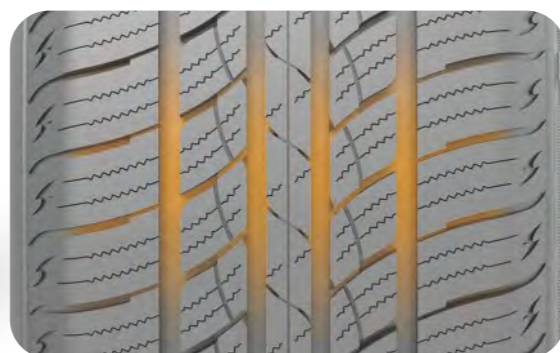

M+S

Rim Size	15 - 22
Series	35 - 75
Speed Rating	T - V

SU318 H/T

Rim (inch)	Size	Service Index	Standard Rim	Section Width (mm)	Overall Diameter (mm)	Max. Load (kg)	Max. Air Pressure (kpa)	UTQG	TT/TL	
15"	225/70R15	100T	6.5J	228	697	800	300	500 A A	TL	
	235/70R15	103T	7.0J	240	711	875	300	500 A A	TL	
	265/70R15	112T	8.0J	272	753	1120	300	500 A A	TL	
	215/75R15	100T	6.0J	216	703	800	300	500 A A	TL	
	225/75R15	102T	6.0J	223	719	850	300	500 A A	TL	
	235/75R15	105T	6.5J	235	733	925	300	500 A A	TL	
16"	265/75R15	112T	7.5J	267	779	1120	300	500 A A	TL	
	215/65R16	98H	6.5J	221	686	750	300	450 A A	TL	
	255/65R16	109T	7.5J	260	738	1030	300	500 A A	TL	
	215/70R16	100T	6.5J	221	708	800	300	500 A A	TL	
	225/70R16	103T	6.5J	228	722	875	300	500 A A	TL	
	235/70R16	106T	7.0J	240	736	950	300	500 A A	TL	
	245/70R16 XL <i>OWL</i>	111T	7.0J	248	750	1090	350	500 A A	TL	
	255/70R16	111T	7.5J	260	764	1090	300	500 A A	TL	
	265/70R16 <i>OWL</i>	112T	8.0J	272	778	1120	300	500 A A	TL	
	275/70R16	114T	8.0J	279	792	1180	300	500 A A	TL	
	225/75R16	104T	6.0J	223	744	900	300	500 A A	TL	
	17"	235/75R16	108T	6.5J	235	758	1000	300	500 A A	TL
245/75R16		111T	7.0J	248	774	1090	300	500 A A	TL	
265/75R16		116T	7.5J	267	804	1250	300	500 A A	TL	
215/60R17		96H	6.5J	221	690	710	300	500 A A	TL	
225/60R17		99T	6.5J	228	702	775	300	500 A A	TL	
235/60R17		102T	7.0J	240	714	850	300	500 A A	TL	
255/60R17 XL		110V	7.5J	260	738	1060	350	500 A A	TL	
265/60R17		108T	8.0J	272	750	1000	300	500 A A	TL	
275/60R17		110T	8.0J	279	762	1060	300	500 A A	TL	
215/65R17		99T	6.5J	221	712	775	300	500 A A	TL	
225/65R17		102T	6.5J	228	724	850	300	500 A A	TL	
18"		235/65R17	104T	7.0J	240	738	900	300	500 A A	TL
	245/65R17	107T	7.0J	248	750	975	300	500 A A	TL	
	255/65R17	110H	7.5J	260	764	1060	300	500 A A	TL	
	265/65R17 <i>OWL</i>	112T	8.0J	272	776	1120	300	500 A A	TL	
	275/65R17	115T	8.0J	279	790	1215	300	500 A A	TL	
	285/65R17	116H	8.5J	292	802	1250	300	500 A A	TL	
	245/70R17	110T	7.0J	248	776	1060	300	500 A A	TL	
	255/70R17	112T	7.5J	260	790	1120	300	500 A A	TL	
	265/70R17	115T	8.0J	272	804	1215	300	500 A A	TL	
	235/50R18	97V	7.5J	245	693	730	300	500 A A	TL	
	18"	225/55R18	98V	7.0J	233	705	750	300	500 A A	TL
		235/55R18	100V	7.5J	245	715	800	300	500 A A	TL
255/55R18 XL		109V	8.0J	265	737	1030	350	500 A A	TL	
225/60R18		100H	6.5J	228	727	800	300	500 A A	TL	
235/60R18		103V	7.0J	240	739	875	300	500 A A	TL	
245/60R18		105T	7.0J	248	751	925	300	500 A A	TL	
19"	255/60R18 XL	112V	7.5J	260	763	1120	350	500 A A	TL	
	265/60R18 XL <i>OWL</i>	114V	8.0J	272	775	1180	350	500 A A	TL	
	285/60R18	116H	8.5J	292	799	1250	300	500 A A	TL	
	235/65R18	106H	7.0J	240	763	950	300	500 A A	TL	
	255/65R18	111T	6.5J	228	749	1090	300	500 A A	TL	
	265/65R18	114T	8.0J	272	801	1180	300	500 A A	TL	
	275/65R18	116T	8.0J	279	815	1250	300	500 A A	TL	
	255/70R18	113T	7.5J	260	815	1150	300	500 A A	TL	
	265/70R18	116T	8.0J	272	829	1250	300	500 A A	TL	
	275/45R19 XL	108V	9.0J	273	731	1000	350	500 A A	TL	
	235/50R19	99V	7.5J	245	719	775	300	500 A A	TL	
	20"	255/50R19 XL	107V	8.0J	265	739	975	350	500 A A	TL
265/50R19 XL		110V	8.5J	277	749	1060	350	500 A A	TL	
225/55R19		99V	7.0J	233	731	772	300	500 A A	TL	
235/55R19 XL		105V	7.5J	245	741	925	350	500 A A	TL	
245/55R19		103V	7.5J	253	753	875	300	500 A A	TL	
255/55R19 XL		111V	8.0J	265	763	1090	350	500 A A	TL	
255/60R19		109H	7.5J	260	789	1030	300	500 A A	TL	
255/65R19 XL		114V	7.5J	260	815	1180	350	500 A A	TL	
315/35R20		106H	11.0J	320	728	950	300	500 A A	TL	
315/35R20 XL		110V	11.0J	320	728	1060	350	500 A A	TL	
275/40R20 XL		106V	9.5J	278	728	950	350	500 A A	TL	
22"		275/45R20 XL	110V	9.0J	273	756	1060	350	500 A A	TL
	245/50R20	102V	7.5J	253	754	850	300	500 A A	TL	
	255/50R20 XL	109V	8.0J	265	764	1030	350	500 A A	TL	
	285/50R20 XL	116V	9.0J	297	794	1250	350	500 A A	TL	
	235/55R20	102H	7.5J	245	766	850	300	500 A A	TL	
	255/55R20	107H	8.0J	265	764	1030	350	500 A A	TL	
	275/55R20 XL	117V	8.5J	284	810	1285	350	500 A A	TL	
	255/60R20	113V	7.5J	260	814	1150	350	500 A A	TL	
	275/60R20	115H	8.0J	279	838	1215	300	500 A A	TL	
	285/45R22	114H	9.5J	285	815	1180	350	500 A A	TL	

• Made in China • Made in Thailand *OWL* Outline White Letters (OWL)



SL369 A/T



Benefits and Features

- Wide tread and multi-stepped grooves increase surface area of tread to enhance traction on both on and off roads
- Zig-zag grooves offers efficient water drainage and enhanced traction on wet road
- Large tread blocks help enhanced stability and handling with less noise on highway
- Aggressive sidewall protectors increase off-road bite and prevent damage from sidewall cut and abrasions

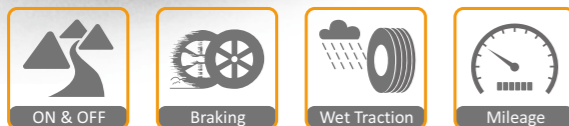
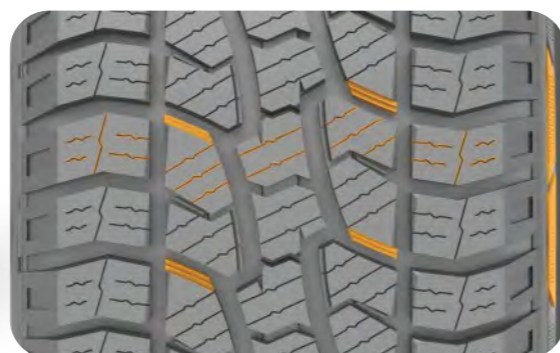

M+S

Rim Size	14 - 20
Series	45 - 85
Speed Rating	Q - V

SL369 A/T

Rim (inch)	Size	Service Index	Standard Rim	Section Width (mm)	Overall Diameter (mm)	Max. Load (kg)	Max. Air Pressure (kpa)	UTQG	TT/TL
14"	175/70R14	84T	5.0J	177	602	500	300	440 A A	TL
	175/80R14	88T	5.0J	177	636	560	300	440 A A	TL
	P215/75R14	100T	6.0J	216	678	800	300	500 A A	TL
	205/70R15	96H	6.0J	209	647	670	300	500 A A	TL
15"	205/65R15	94H	6.0J	209	647	670	300	500 A A	TL
	205/70R15	96H	6.0J	209	669	710	300	500 A A	TL
	225/70R15	100T	6.5J	228	697	800	300	500 A A	TL
	235/70R15	103S	7.0J	240	711	875	300	500 A A	TL
	265/70R15	112T	8.0J	272	753	1120	300	500 A A	TL
	P215/75R15	100S	6.0J	216	703	800	300	500 A A	TL
	235/75R15 XL	109S	6.5J	235	733	1030	350	500 A A	TL
	245/75R15	108T	7.0J	248	749	1000	300	500 A A	TL
16"	205/60R16	92H	6.0J	209	652	630	300	500 A A	TL
	235/60R16	100T	7.0J	240	688	800	300	500 A A	TL
	215/70R16	100S	6.5J	221	708	800	300	500 A A	TL
	225/70R16	103S	6.5J	228	722	875	300	500 A A	TL
	235/70R16	106S	7.0J	240	736	950	300	500 A A	TL
	245/70R16 XL	111S	7.0J	248	750	1090	350	500 A A	TL
	255/70R16	111T	7.5J	260	764	1090	300	500 A A	TL
	265/70R16	112S	8.0J	272	778	1120	300	500 A A	TL
	275/70R16	114S	8.0J	279	792	1180	300	500 A A	TL
	225/75R16 XL	108S	6.0J	223	744	1000	350	500 A A	TL
	235/75R16 XL	112S	6.5J	235	758	1120	350	500 A A	TL
	245/75R16	111S	7.0J	248	774	1090	300	500 A A	TL
	265/75R16	116S	7.5J	267	804	1250	300	500 A A	TL
	205/80R16 XL	104S	5.5J	203	734	900	350	440 A A	TL
	215/80R16 XL	107S	6.0J	216	750	975	350	440 A A	TL
	17"	225/65R17	102T	6.5J	228	724	850	300	500 A A
235/65R17		104S	7.0J	240	738	900	300	500 A A	TL
245/65R17		107S	7.0J	248	750	975	300	500 A A	TL
255/65R17		110T	7.5J	260	764	1060	300	500 A A	TL
265/65R17		112S	8.0J	272	776	1120	300	500 A A	TL
225/70R17 XL		108S	6.5J	228	748	1000	350	500 A A	TL
245/70R17		110T	7.0J	248	776	1000	300	500 A A	TL
255/70R17		112T	7.5J	260	790	1120	300	500 A A	TL
265/70R17		115T	8.0J	272	804	1215	300	500 A A	TL
285/70R17		117T	8.5J	292	832	1285	300	500 A A	TL
235/75R17		109T	6.5J	235	784	1030	300	500 A A	TL
245/75R17		112T	7.0J	248	800	1120	300	500 A A	TL
255/75R17	115T	7.0J	255	814	1215	300	500 A A	TL	
18"	265/60R18	110T	8.0J	272	775	1060	300	500 A A	TL
	285/60R18	116T	8.5J	292	799	1250	300	500 A A	TL
	265/65R18	114T	8.0J	272	801	1180	300	500 A A	TL
	275/65R18	116T	8.0J	279	815	1250	300	500 A A	TL
20"	275/45R20 XL	110H	9.0J	273	756	1060	350	500 A A	TL
	265/50R20 XL	111T	8.5J	277	774	1090	350	500 A A	TL
	285/50R20 XL	116V	9.0J	297	794	1250	350	500 A A	TL
	275/55R20	113S	8.5J	284	810	1150	300	500 A A	TL
275/60R20	115T	8.0J	279	838	1215	300	500 A A	TL	

● Made in China ● Made in Thailand ● OWL Outline White Letters (OWL)



TERRA LEGEND SL399



Benefits and Features

- Wider tread design and new compound help longer tread life On & Off road
- Side-Biter lugs in the sidewall improve traction in mud and rough road
- Aggressive sidewall design provide increased traction, especially in aired-down driving situations

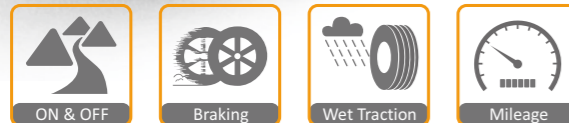
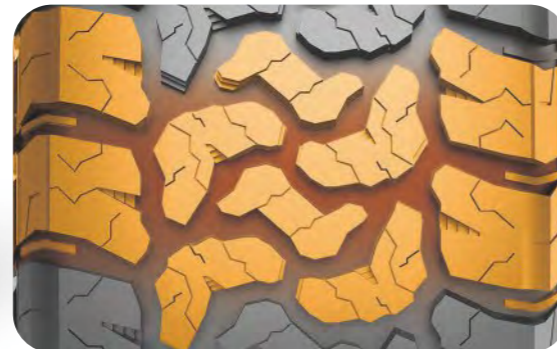

M+S

Rim Size	15 - 20
Series	50 - 75
Speed Rating	Q - V

TERRA LEGEND SL399

Rim (inch)	Size	Service Index	Standard Rim	Section Width (mm)	Overall Diameter (mm)	Max. Load (kg)	Max. Air Pressure (kpa)	UTQG	TT/TL	Rim (inch)	Size	LR/PR	Service Index	Standard Rim	Section Width (mm)	Overall Diameter (mm)	Max. Load (kg)	Max. Air Pressure (kpa)	TT/TL
15"	235/75R15 XL	109S	6.5J	235	733	1030	350	500 A A	TL	15"	31x10.50R15LT	C/6PR	109S	8.5J	268	775	1030	350	TL
16"	215/70R16	100S	6.5J	221	708	800	300	500 A A	TL	15"	31x10.50R15LT	C/6PR	109Q	8.5J	268	775	1030	350	TL
	235/70R16	106S	7.0J	240	736	950	300	500 A A	TL		LT215/75R15	D/8PR	106/103Q	6.0J	216	703	950/875	450	TL
	245/70R16 XL	111S	7.0J	248	750	1090	350	500 A A	TL		LT235/75R15	C/6PR	104/101R	6.5J	235	733	900/825	350	TL
	255/70R16	111T	7.5J	260	764	1090	300	500 A A	TL		LT235/75R15	C/6PR	104/101Q	6.5J	235	733	900/825	350	TL
	265/70R16	112S	8.0J	272	778	1120	300	500 A A	TL	16"	LT245/70R16	E/10PR	118/115Q	7.0J	248	750	1320/1215	550	TL
	275/70R16	114S	8.0J	279	792	1180	300	500 A A	TL		LT245/75R16	E/10PR	120/116Q	7.0J	248	774	1380/1260	550	TL
17"	245/65R17	107S	7.0J	248	750	975	300	500 A A	TL		LT265/75R16	E/10PR	123/120Q	7.5J	267	804	1550/1400	550	TL
	265/65R17	112S	8.0J	272	776	1120	300	500 A A	TL		LT265/75R16	D/8PR	121/118Q	7.5J	267	804	1450/1320	450	TL
	265/70R17	115T	8.0J	272	804	1215	300	500 A A	TL	17"	LT265/65R17	E/10PR	120/117Q	8.0J	272	776	1400/1285	550	TL
18"	235/60R18	103T	7.0J	240	739	875	300	500 A A	TL		LT285/65R17	E/10PR	121/118Q	8.5J	292	802	1450/1320	550	TL
	255/60R18 XL	112T	7.5J	260	763	1120	350	500 A A	TL		LT245/70R17	E/10PR	119/116Q	7.0J	248	776	1360/1250	550	TL
	255/60R18 XL	112V	7.5J	260	763	1120	350	500 A A	TL		LT265/70R17	E/10PR	123/120Q	8.0J	272	804	1550/1400	550	TL
	265/60R18	110T	8.0J	272	775	1060	300	500 A A	TL		LT265/70R17	D/8PR	121/118Q	8.0J	272	804	1450/1320	450	TL
	285/60R18	116T	8.5J	292	799	1250	300	500 A A	TL		LT285/70R17	E/10PR	126/123Q	8.5J	292	832	1700/1550	550	TL
	235/65R18	106T	7.0J	240	763	950	300	500 A A	TL		LT285/70R17	D/8PR	121/118Q	8.5J	292	832	1450/1320	450	TL
	265/65R18	114T	8.0J	272	801	1180	300	500 A A	TL		LT315/70R17	E/10PR	126/123Q	9.5J	323	874	1700/1550	450	TL
19"	245/55R19	103T	7.5J	253	753	875	300	500 A A	TL	18"	LT265/70R18	E/10PR	124/121R	8.0J	272	829	1600/1450	550	TL
20"	265/50R20 XL	111T	8.5J	277	774	1090	350	500 A A	TL	20"	LT285/50R20	E/10PR	119/116Q	9.0J	297	794	1360/1250	550	TL
	275/55R20 XL	117T	8.5J	284	810	1285	350	500 A A	TL										

● Made in China ● Made in Thailand



RUGGED LEGEND SL339



Benefits and Features

- Optimized tread design with wide tread large block and variable pitch pattern
- Two-wide circumferential zigzag grooves and Center cross pattern grooves with stone ejectors Provide superb off-road traction throughout the tyre's wear life with stone ejectors to help prevent stone drilling
- Aggressive sidewall design offer customization with a distinct look on each side of the tyre
- Open shoulder design and wide lateral grooves ensure excellent driving performance of the tyre

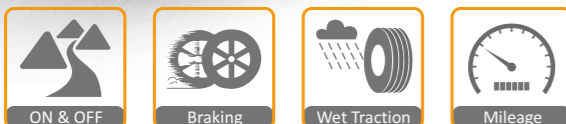

M+S

Rim Size	15 - 20
Series	50 - 85
Speed Rating	Q - T

RUGGED LEGEND SL339

Rim (inch)	Size	Service Index	Standard Rim	Section Width (mm)	Overall Diameter (mm)	Max. Load (kg)	Max. Air Pressure (kpa)	UTQG	TT/TL	Rim (inch)	Size	LR/PR	Service Index	Standard Rim	Section Width (mm)	Overall Diameter (mm)	Max. Load (kg)	Max. Air Pressure (kpa)	TT/TL
15"	235/75R15	109S	6.5J	235	733	1030	350	500 A A	TL	15"	LT215/75R15	D/8PR	106/103Q	6.0J	223	719	950/875	450	TL
16"	245/70R16 XL	111S	7.0J	248	750	1090	350	500 A A	TL	16"	LT235/75R15	D/8PR	110/107Q	6.5J	733	739	1060/975	450	TL
	255/70R16	111T	7.5J	260	764	1090	300	500 A A	TL		31x10.50R15LT	C/6PR	109Q	8.5J	268	775	1030	350	TL
	265/70R16	112S	8.0J	272	778	1120	300	500 A A	TL		33x12.50R15LT	C/6PR	108Q	10.0J	318	826	1000	250	TL
	275/70R16	114S	8.0J	279	792	1180	300	500 A A	TL	16"	LT245/70R16	E/10PR	118/115Q	7.0J	248	750	1320/1215	550	TL
17"	245/65R17	107S	7.0J	248	750	975	300	500 A A	TL	17"	LT265/70R16	E/10PR	121/118Q	8.0J	272	778	1450/1320	550	TL
	265/65R17	112S	8.0J	272	776	1120	300	500 A A	TL		LT245/75R16	E/10PR	120/116Q	7.0J	248	774	1380/1260	550	TL
18"	265/60R18	110T	8.0J	272	775	1060	300	500 A A	TL		LT265/75R16	E/10PR	123/120Q	7.5J	267	804	1550/1400	450	TL
	285/60R18	116T	8.5J	292	799	1250	300	500 A A	TL		LT285/75R16	E/10PR	126/123Q	8.0J	286	834	1700/1550	550	TL
	265/65R18	114T	8.0J	272	801	1180	300	500 A A	TL		LT235/85R16	E/10PR	120/116Q	6.5J	235	806	1380/1260	550	TL
20"	265/50R20 XL	111T	8.5J	277	774	1090	350	500 A A	TL	17"	LT265/65R17	E/10PR	120/117Q	8.0J	272	776	1400/1285	550	TL
	275/55R20 XL	117T	8.5J	284	810	1285	350	500 A A	TL		LT245/70R17	E/10PR	119/116Q	7.0J	248	776	1360/1250	550	TL
											LT265/70R17	E/10PR	123/120Q	8.0J	272	804	1550/1400	550	TL
											LT285/70R17	E/10PR	126/123Q	8.5J	292	832	1700/1550	550	TL
											LT285/65R17	E/10PR	121/118Q	8.5J	292	802	1450/1320	550	TL

Made in Thailand



MUD LEGEND SL366



Benefits and Features

- Especially designed for unpaved tough roads (Professional off-road tyres)
- Various shoulder blocks promote driving and handling performance on tough roads
- Perfect grip on tough surfaces such as mud and sand



M+S

Rim Size	14 - 20
Series	50 - 85
Speed Rating	Q - T

MUD LEGEND SL366

Rim (inch)	Size	Service Index	Standard Rim	Section Width (mm)	Overall Diameter (mm)	Max. Load (kg)	Max. Air Pressure (kpa)	UTQG	TT/TL	Rim (inch)	Size	LR/PR	Service Index	Standard Rim	Section Width (mm)	Overall Diameter (mm)	Max. Load (kg)	Max. Air Pressure (kpa)	TT/TL
18"	265/60R18	110T	8.0J	272	775	1060	300	500 A A	TL	14"	185R14C	D/8PR	102/100Q	5.5J	188	650	850/800	450	TL
	285/60R18	116T	8.5J	292	799	1250	300	500 A A	TL		195R14C	D/8PR	106/104Q	5.5J	198	666	950/900	450	TL
20"	265/50R20 XL	111T	8.5J	277	774	1090	350	500 A A	TL	15"	205/70R15C	C/6PR	104/102Q	6.0J	209	669	900/850	375	TL
	275/55R20	113S	8.5J	284	810	1150	300	500 A A	TL		30x9.50R15LT	C/6PR	104Q	7.5J	240	756	900	350	TL
											31x10.50R15LT	C/6PR	109Q	8.5J	268	781	1030	350	TL
											32x11.50R15LT	C/6PR	113Q	9.0J	290	807	1150	350	TL
											33x12.50R15LT	C/6PR	108Q	10.0J	318	832	1000	250	TL
											35x12.50R15LT	C/6PR	113Q	10.0J	318	883	1150	250	TL
											LT215/75R15	C/6PR	100/97Q	6.0J	216	703	800/730	350	TL
											LT225/75R15	C/6PR	102/99Q	6.0J	223	719	850/775	350	TL
											LT235/75R15	C/6PR	104/101Q	6.5J	235	739	900/825	350	TL
											LT235/75R15	D/8PR	110/107Q	6.5J	235	739	1060/975	450	TL
										16"	205R16C	D/8PR	110/108Q	6.0J	208	736	1060/1000	450	TL
											LT225/75R16	E/10PR	115/112Q	6.0J	223	750	1215/1120	550	TL
											LT245/75R16	E/10PR	120/116Q	7.0J	248	780	1380/1260	550	TL
											LT265/75R16	E/10PR	123/120Q	7.5J	267	810	1550/1400	550	TL
											LT285/75R16	E/10PR	126/123Q	8.0J	286	840	1700/1550	550	TL
											LT315/75R16	E/10PR	127/124R	8.5J	313	878	1750/1600	450	TL
											LT235/85R16	E/10PR	120/116Q	6.5J	235	812	1380/1260	550	TL
										17"	35x12.50R17LT	E/10PR	121Q	10.0J	318	883	1450	450	TL
											37x12.50R17LT	D/8PR	124Q	10.0J	318	934	1600	350	TL
											LT265/65R17	E/10PR	120/117Q	8.0J	272	775	14000/1285	550	TL
											LT245/70R17	E/10PR	119/116Q	7.0J	248	782	1360/1250	550	TL
											LT265/70R17	E/10PR	121/118Q	8.0J	272	810	1450/1320	550	TL
											LT285/70R17	E/10PR	121/118Q	8.5J	292	832	1450/1320	550	TL
											LT315/70R17	E/10PR	121/118Q	9.5J	323	880	1450/1320	450	TL
18"	35x12.50R18LT	E/10PR	123Q	10.0J	318	883	1550	450	TL	20"	33x12.50R20LT	E/10PR	114Q	10.0J	318	832	1180	450	TL
											35x12.50R20LT	E/10PR	121Q	10.0J	318	883	1450	450	TL

Made in China



MUD LEGEND SL376



Benefits and Features

- New generation premium tyres designed for unpaved tough road (professional off-road tyre)
- Aggressive and open shoulder design provides extreme grips for various terrains
- Stone rejectors protect the tyre casing and minimize stone drilling for long-lasting off-road experience

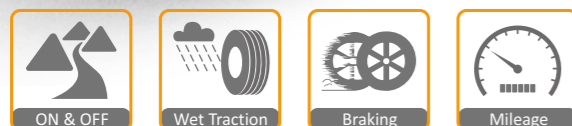

M+S

Rim Size	15 - 26
Series	55 - 85
Speed Rating	Q - R

MUD LEGEND SL376

Rim (inch)	Size	LR/PR	Service Index	Standard Rim	Section Width (mm)	Overall Diameter (mm)	Max. Load (kg)	Max. Air Pressure (kpa)	TT/TL	Rim (inch)	Size	LR/PR	Service Index	Standard Rim	Section Width (mm)	Overall Diameter (mm)	Max. Load (kg)	Max. Air Pressure (kpa)	TT/TL
15"	30x9.50R15LT	C/6PR	104Q	7.5J	240	756	900	350	TL	17"	LT245/75R17	E/10PR	121/118Q	7.0J	248	806	1450/1320	550	TL
	31x10.50R15LT	C/6PR	109Q	8.5J	268	781	1030	350	TL		LT255/75R17	C/6PR	111/108Q	7.0J	255	820	1000/1090	350	TL
	32x11.50R15LT	C/6PR	113Q	9.0J	290	807	1150	350	TL		LT235/80R17	E/10PR	120/117Q	6.5J	235	814	1285/1400	550	TL
	33x12.50R15LT	C/6PR	108Q	10.0J	318	832	1000	250	TL		35x12.50R18LT	E/10PR	123Q	10.0J	318	883	1550	450	TL
16"	35x12.50R15LT	C/6PR	113Q	10.0J	318	883	1150	250	TL	LT275/65R18	E/10PR	123/120Q	8.0J	279	821	1400/1550	550	TL	
	LT235/75R15	C/6PR	104/101Q	6.5J	235	739	900/825	350	TL	LT275/70R18	E/10PR	125/122Q	8.0J	279	849	1500/1650	550	TL	
	LT245/75R16	E/10PR	120/116Q	7.0J	248	780	1380/1260	550	TL	35x12.50R20LT	E/10PR	121Q	10.0J	318	883	1450	450	TL	
	LT265/75R16	E/10PR	123/120Q	7.5J	267	810	1550/1400	550	TL	LT305/55R20	F/12PR	125/122Q	9.5J	316	850	1500/1650	550	TL	
17"	LT285/75R16	E/10PR	126/123Q	8.0J	286	840	1700/1550	550	TL	LT275/65R20	E/10PR	126/123Q	8.0J	279	872	1550/1700	550	TL	
	LT315/75R16	E/10PR	127/124R	8.5J	313	878	1750/1600	450	TL	35x12.50R22LT	F/12PR	121Q	10.0J	318	883	1450	550	TL	
	LT235/85R16	E/10PR	120/116Q	6.5J	235	812	1380/1260	550	TL	37x13.50R22LT	F/12PR	128Q	11.0J	345	934	1800	550	TL	
	35x12.50R17LT	E/10PR	125Q	10.0J	318	883	1650	450	TL	40x15.50R24LT	F/12PR	128Q	12.5J	395	1010	1800	550	TL	
17"	LT265/70R17	E/10PR	123/120Q	8.0J	272	810	1550/1400	550	TL	40x15.50R26LT	E/10PR	126Q	12.5J	395	1010	1700	450	TL	
	LT285/70R17	E/10PR	126/123Q	8.5J	292	832	1700/1550	550	TL										

Made in Thailand



MUD LEGEND SL378



Benefits and Features

- The aggressive tread design is engineered to provide strong biting edges.
- The staggered, off-center tread blocks provide increased traction while enhancing road performance.
- Built to handle rugged terrains anywhere and to take you on extreme adventures
- Robust shoulder design helps to minimizing cuts

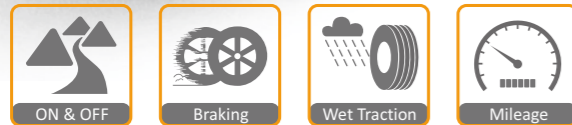

M+S

Rim Size	15 - 18
Series	60 - 85
Speed Rating	Q

MUD LEGEND SL378

Rim (inch)	Size	LR/PR	Service Index	Standard Rim	Section Width (mm)	Overall Diameter (mm)	Max. Load (kg)	Max. Air Pressure (kpa)	TT/TL
15"	31x10.50R15LT	C/6PR	109Q	8.5J	268	781	1030	350	TL
	33x12.50R15LT	C/6PR	108Q	10.0J	318	832	1000	250	TL
	LT215/75R15	C/6PR	100/97Q	6.0J	216	703	800/730	350	TL
	LT235/75R15	C/6PR	104/101Q	6.5J	235	739	900/825	350	TL
16"	LT235/75R15	D/8PR	110/107Q	6.5J	235	739	1060/975	450	TL
	LT245/70R16	E/10PR	118/115Q	7.0J	248	750	1320/1215	550	TL
16"	LT265/70R16	E/10PR	121/118Q	8.0J	272	784	1450/1320	550	TL
	LT245/75R16	E/10PR	120/116Q	7.0J	248	780	1380/1260	550	TL
17"	LT265/75R16	E/10PR	123/120Q	7.5J	267	810	1550/1400	550	TL
	LT285/75R16	E/10PR	126/123Q	8.0J	286	840	1700/1550	550	TL
	LT235/85R16	E/10PR	120/116Q	6.5J	235	812	1380/1260	550	TL
17"	LT265/65R17	E/10PR	120/117Q	8.0J	272	775	1400/1285	550	TL
	LT245/70R17	E/10PR	119/116Q	7.0J	248	776	1360/1250	550	TL
17"	LT265/70R17	E/10PR	121/118Q	8.0J	272	810	1450/1320	550	TL
	LT285/70R17	E/10PR	121/118Q	8.5J	292	832	1450/1320	550	TL
18"	LT265/60R18	E/10PR	119/116Q	8.0J	272	775	1360/1250	550	TL

Made in China



TRAC LEGEND SL315



Benefits and Features

- 4 Zig-zag grooves and the snow sipes improves all-season performance
- The interblock tie-bar at the centre ribs improve steering response
- Double-ply casing and double steel belts construction guarantee a outstanding load capacity and durability performance

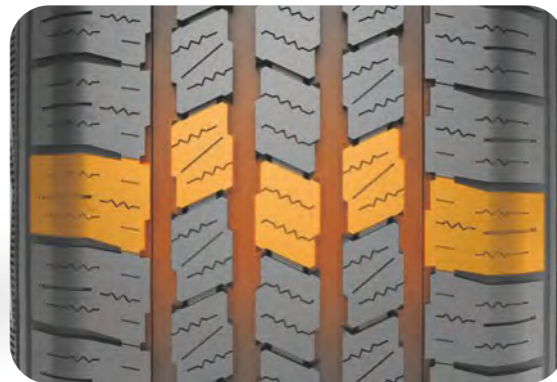

Rim Size	15 - 18
Series	65 - 85
Speed Rating	Q - R

TRAC LEGEND SL315

Rim (inch)	Size	LR/PR	Service Index	Standard Rim	Section Width (mm)	Overall Diameter (mm)	Max. Load (kg)	Max. Air Pressure (kpa)	TT/TL	Rim (inch)	Size	LR/PR	Service Index	Standard Rim	Section Width (mm)	Overall Diameter (mm)	Max. Load (kg)	Max. Air Pressure (kpa)	TT/TL
15"	31x10.50R15LT	C/6PR	109Q	8.5J	268	775	1030	350	TL	16"	LT215/85R16	E/10PR	115/112Q	6.0J	216	772	1215/1120	550	TL
	LT215/75R15	C/6PR	100/97Q	6.0J	216	703	800/730	350	TL		LT235/85R16	E/10PR	120/116Q	6.5J	235	806	1380/1260	550	TL
	LT235/75R15	C/6PR	104/101Q	6.5J	235	733	900/825	350	TL		17"	LT245/70R17	E/10PR	119/116Q	7.0J	248	776	1360/1250	550
16"	185/75R16C	D/8PR	104/102R	5.0J	184	684	900/850	475	TL	LT265/70R17		E/10PR	121/118Q	8.0J	272	804	1450/1320	550	TL
	LT225/75R16	E/10PR	115/112Q	6.0J	223	744	1215/1120	550	TL	LT285/70R17		D/8PR	121/118Q	8.5J	292	832	1450/1320	450	TL
	LT245/75R16	E/10PR	120/116Q	7.0J	248	774	1380/1260	550	TL	LT245/75R17	E/10PR	121/118Q	7.0J	248	800	1450/1320	550	TL	
	LT265/75R16	E/10PR	123/120Q	7.5J	267	804	1550/1400	550	TL	LT235/80R17	E/10PR	120/117Q	6.5J	235	808	1400/1285	550	TL	
LT285/75R16	D/8PR	122/119Q	8.0J	286	834	1500/1360	450	TL	18"	LT275/65R18	E/10PR	123/120Q	8.0J	279	815	1550/1400	550	TL	

● Made in China ● Made in Thailand



SL309



Benefits and Features

- All-season tread design with long tread life
- Double-ply casing construction handles heavy loads at highway speed and delivers outstanding durability
- Double steel belts plies and double full jointless nylon cap plies improve handling stability and durability
- Wide circumferential grooves helps to evacuate water quickly and efficiently



Rim Size	15 - 18
Series	65 - 85
Speed Rating	Q - R

SL309

Rim (inch)	Size	LR/PR	Service Index	Standard Rim	Section Width (mm)	Overall Diameter (mm)	Max. Load (kg)	Max. Air Pressure (kpa)	TT/TL	Rim (inch)	Size	LR/PR	Service Index	Standard Rim	Section Width (mm)	Overall Diameter (mm)	Max. Load (kg)	Max. Air Pressure (kpa)	TT/TL
15"	31x10.50R15LT	C/6PR	109Q	8.5J	268	775	1030	350	TL	16"	LT215/85R16	E/10PR	115/112Q	6.0J	216	772	1215/1120	550	TL
	LT215/75R15	C/6PR	100/97Q	6.0J	216	703	800/730	350	TL		LT235/85R16	E/10PR	120/116Q	6.5J	235	806	1380/1260	550	TL
	LT235/75R15	C/6PR	104/101Q	6.5J	235	733	900/825	350	TL		17"	LT245/70R17	E/10PR	119/116Q	7.0J	248	776	1360/1250	550
16"	185/75R16C	D/8PR	104/102R	5.0J	184	684	900/850	475	TL	LT265/70R17		E/10PR	121/118Q	8.0J	272	804	1450/1320	550	TL
	LT225/75R16	E/10PR	115/112Q	6.0J	223	744	1215/1120	550	TL	LT285/70R17		D/8PR	121/118Q	8.5J	292	832	1450/1320	450	TL
	LT245/75R16	E/10PR	120/116Q	7.0J	248	774	1380/1260	550	TL	LT245/75R17	E/10PR	121/118Q	7.0J	248	800	1450/1320	550	TL	
	LT265/75R16	E/10PR	123/120Q	7.5J	267	804	1550/1400	550	TL	LT235/80R17	E/10PR	120/117Q	6.5J	235	808	1400/1285	550	TL	
LT285/75R16	D/8PR	122/119Q	8.0J	286	834	1500/1360	450	TL	18"	LT275/65R18	E/10PR	123/120Q	8.0J	279	815	1550/1400	550	TL	

● Made in China ● Made in Thailand



SC328



Benefits and Features

- Wide four ribs improve miles to tread life
- Zig-zag grooves offers enhanced traction on wet road
- Combination construction of polyester casing and steel belts provide outstanding durability

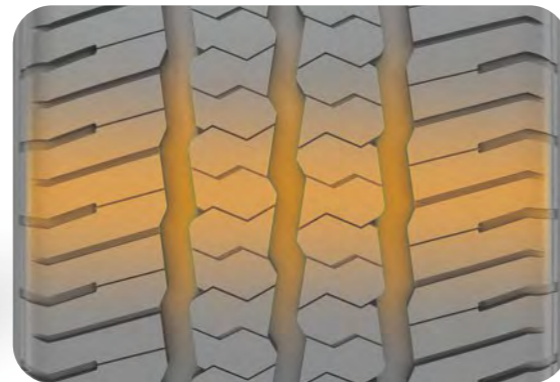

M+S

Rim Size	12 - 16
Series	60 - 75
Speed Rating	Q - T

SC328

Rim (inch)	Size	LR/PR	Service Index	Standard Rim	Section Width (mm)	Overall Diameter (mm)	Max. Load (kg)	Max. Air Pressure (kpa)	TT/TL	Rim (inch)	Size	LR/PR	Service Index	Standard Rim	Section Width (mm)	Overall Diameter (mm)	Max. Load (kg)	Max. Air Pressure (kpa)	TT/TL
12"	155R12C	C/6PR	83/81Q	4.5B	157	550	487/462	350	TL	15"	215/70R15C	D/8PR	109/107R	6.5J	221	683	1030/975	475	TL
	155R12C	D/8PR	88/86Q	4.5B	157	550	560/530	450	TL		225/70R15C	D/8PR	112/110R	6.5J	228	697	1120/1060	450	TL
13"	155R13C	D/8PR	90/88S	4.5B	157	578	600/560	450	TL	16"	175R16C	C/6PR	98/96Q	5.0J	178	684	750/710	375	TL
	165R13C	C/6PR	91/89Q	4.5B	167	596	615/580	375	TL		215/60R16C	D/8PR	108/106T	6.5J	221	664	1000/950	475	TL
	165R13C	D/8PR	94/92Q	4.5B	165	594	670/650	450	TL		195/65R16C	D/8PR	104/102T	6.0J	201	660	900/850	475	TL
	175R13C	D/8PR	97/95Q	5.0B	178	609	730/690	450	TL		205/65R16C	D/8PR	107/105T	6.0J	209	672	975/925	475	TL
14"	165/70R13C	C/6PR	88/86S	5.0B	170	562	560/530	375	TL	215/65R16C	D/8PR	109/107R	6.5J	221	686	1030/975	475	TL	
	185R14C	D/8PR	102/100Q	5.5J	188	650	850/800	450	TL	225/65R16C	D/8PR	112/110R	6.5J	228	698	1120/1060	475	TL	
	195R14CWSW	D/8PR	106/104Q	5.5J	198	666	950/900	450	TL	235/65R16C	D/8PR	115/113R	7.0J	240	712	1215/1150	475	TL	
	205R14C	D/8PR	109/107R	6.0J	208	686	1030/975	450	TL	235/65R16C	F/12PR	121/119R	7.0J	240	712	1450/1360	575	TL	
	215R14C	D/8PR	112/110Q	6.0J	218	700	1120/1060	450	TL	215/70R16C	C/6PR	108/106T	6.5J	221	708	1000/950	375	TL	
	165/70R14C	C/6PR	89/87R	5.0J	170	588	580/545	375	TL	215/70R16C	E/10PR	113/111Q	6.5J	221	708	1150/1090	585	TL	
	205/70R14C	C/6PR	102/100R	6.0J	209	644	850/800	375	TL	175/75R16C	D/8PR	101/99Q	5.0J	177	668	825/775	475	TL	
	215/75R14C	D/8PR	112/110Q	6.0J	216	678	1120/1060	475	TL	195/75R16C	D/8PR	107/105R	5.5J	196	698	975/925	475	TL	
	185R15C	D/8PR	103/102R	5.5J	188	674	875/850	450	TL	195/75R16C	E/10PR	110/108R	5.5J	196	698	1060/1000	525	TL	
	195R15C	D/8PR	106/104R	5.5J	198	690	950/900	450	TL	205/75R16C	D/8PR	110/108Q	5.5J	203	714	1060/1000	475	TL	
215R15C	D/8PR	112/110Q	6.0J	218	724	1120/1060	450	TL	205/75R16C	E/10PR	113/111R	5.5J	203	714	1150/1090	525	TL		
205/65R15C	C/6PR	102/100T	6.0J	209	647	850/800	375	TL	205/75R16C	F/12PR	116/114R	5.5J	203	714	1250/1180	575	TL		
195/70R15C	D/8PR	104/102R	6.0J	201	655	900/850	450	TL	215/75R16C	D/8PR	113/111Q	6.0J	216	728	1150/1090	475	TL		
205/70R15C	D/8PR	106/104R	6.0J	209	669	950/900	475	TL	215/75R16C	E/10PR	116/114R	6.0J	216	728	1250/1180	525	TL		

● Made in China
 ● Made in Thailand
 ● WSW White Sidewall Tyre (WSW)



SC326



Benefits and Features

- ▶ Balanced pattern arrangement for increased traction
- ▶ Latest profile design ensure longer tyre life
- ▶ Improved casing structure provides outstanding durability



Rim Size	14 - 16
Series	65 - 75
Speed Rating	Q - T

SC326

Rim (inch)	Size	LR/PR	Service Index	Standard Rim	Section Width (mm)	Overall Diameter (mm)	Max. Load (kg)	Max. Air Pressure (kpa)	TT/TL
14"	185R14C	D/8PR	102/100R	5.5J	188	650	850/800	450	TL
	195R14C	D/8PR	106/104Q	5.5J	198	666	950/900	450	TL
	195R14C	E/10PR	110/108Q	5.5J	198	666	1060/1000	525	TL
	205R14C	D/8PR	109/107Q	6.0J	208	686	1030/975	450	TL
	205R14C	E/10PR	113/111Q	6.0J	208	686	1150/1090	525	TL
15"	195R15C	D/8PR	106/104R	5.5J	198	690	950/900	450	TL
	215R15C	D/8PR	112/110Q	6.0J	218	724	1120/1060	450	TL
15"	205/70R15C	D/8PR	106/104R	6.0J	209	669	950/900	475	TL
	205/70R15C	E/10PR	108/106Q	6.0J	209	669	1000/950	525	TL
	215/70R15C	D/8PR	109/107R	6.5J	221	683	1030/975	475	TL
	225/75R15C	D/8PR	116/114Q	6.0J	223	719	1250/1180	475	TL
	215/65R16C	D/8PR	109/107R	6.5J	221	686	1030/975	475	TL
16"	235/65R16C	F/12PR	121/119R	7.0J	240	712	1450/1360	575	TL
	215/70R16C	C/6PR	108/106T	6.5J	221	708	1000/950	375	TL

Made in Thailand



H188



Benefits and Features

- Valuable commercial light truck tyre for vehicles on paved roads
- 3 rib grooves provides improved handling and comfort
- Polyester tyre casing with steel belts for good durability

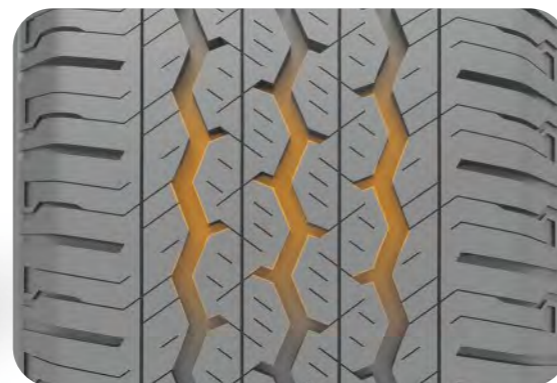

Rim Size	12 - 16
Series	60 - 75
Speed Rating	Q - H

H188

Rim (inch)	Size	LR/PR	Service Index	Standard Rim	Section Width (mm)	Overall Diameter (mm)	Max. Load (kg)	Max. Air Pressure (kpa)	TT/TL
12"	155R12C	C/6PR	83/81Q	4.5B	157	550	487/462	350	TL
	155R12C	D/8PR	88/86Q	4.5B	157	550	560/530	450	TL
13"	155R13C	D/8PR	90/88S	4.5B	157	578	600/560	450	TL
	165R13C	C/6PR	91/89S	4.5B	167	596	615/580	375	TL
	165/70R13C	C/6PR	88/86S	5.0J	170	562	560/530	375	TL
14"	185R14CWSW	D/8PR	102/100R	5.5J	188	650	850/800	450	TL
	195R14CWSW	D/8PR	106/104Q	5.5J	198	666	950/900	450	TL
	175/70R14C	C/6PR	95/93S	5.0J	177	602	690/650	375	TL
	175/75R14C	D/8PR	94/91S	5.0J	177	618	775/750	475	TL
	195R15CWSW	D/8PR	106/104R	5.5J	198	690	950/900	450	TL
15"	205/65R15C	C/6PR	102/100T	6.0J	209	647	850/800	375	TL
	215/65R15C	C/6PR	104/102T	6.5J	221	661	900/850	375	TL
	195/70R15C	D/8PR	104/102R	6.0J	201	655	900/850	450	TL
	205/70R15C	D/8PR	106/104R	6.0J	209	669	950/900	475	TL
	215/70R15CWSW	D/8PR	109/107R	6.5J	221	683	1030/975	475	TL
	225/70R15CWSW	D/8PR	112/110R	6.5J	228	697	1120/1060	450	TL
	195/60R16C	C/6PR	99/97H	6.0J	201	640	775/730	375	TL
16"	215/60R16C	D/8PR	108/106T	6.5J	221	664	1000/950	475	TL
	195/65R16C	D/8PR	104/102T	6.0J	201	660	900/850	475	TL
	205/65R16C	D/8PR	107/105T	6.0J	209	672	975/925	475	TL
	215/65R16C	D/8PR	109/107T	6.5J	221	686	1030/975	475	TL
	225/65R16C	D/8PR	112/110T	6.5J	228	698	1120/1060	475	TL
	235/65R16C	D/8PR	115/113R	7.0J	240	712	1215/1150	475	TL
	185/75R16C	D/8PR	104/102R	5.0J	184	684	900/850	475	TL
	195/75R16C	D/8PR	107/105R	5.5J	196	698	975/925	475	TL
	205/75R16C	D/8PR	110/108Q	5.5J	203	714	1060/1000	475	TL
	215/75R16C	D/8PR	113/111Q	6.0J	216	728	1150/1090	475	TL
225/75R16C	E/10PR	118/116R	6.0J	223	744	1320/1250	525	TL	

● Made in China
 ● Made in Thailand
 WSW White SideWall (WSW)



ST313



Benefits and Features

- Applicable for mini-bus, van and commercial light trucks
- Strong sidewall design enables high durability and fights off cuts and abrasion in city roads
- Triply polyester belts plies creates strength bearing heavy loads with superior stability



Rim Size	15 - 16
Series	75 - 85
Speed Rating	L - R

ST313

Rim (inch)	Size	LR/PR	Service Index	Standard Rim	Section Width (mm)	Overall Diameter (mm)	Max. Load (kg)	Max. Air Pressure (kpa)	TT/TL
15"	6.50R15LT	E/10PR	107/105N	5.5F	180	730	975/925	560	TT/TL
	7.00R15LT	E/10PR	110/106N	5.5F	200	750	1060/950	560	TT/TL
	195/75R15C	F/12PR	109/107L	5.5J	196	673	1030/975	600	TL
16"	6.50R16LT	E/10PR	108/107N	5.5F	185	750	1000/975	560	TT/TL
	7.00R16LT	F/12PR	117/116N	5.5F	200	775	1285/1250	670	TT/TL
	7.00R16LT	F/12PR	117/116N	5.5F	200	775	1285/1250	670	TT/TL

🇨🇳 Made in China 🇹🇭 Made in Thailand



Zuper Snow Z-507



Benefits and Features

- Asymmetric pattern design provides superior handling on snow surface
- Optimised lateral groove angle offers strong snow performance
- Special zigzag traction sipes improves traction and braking performance on snow roads

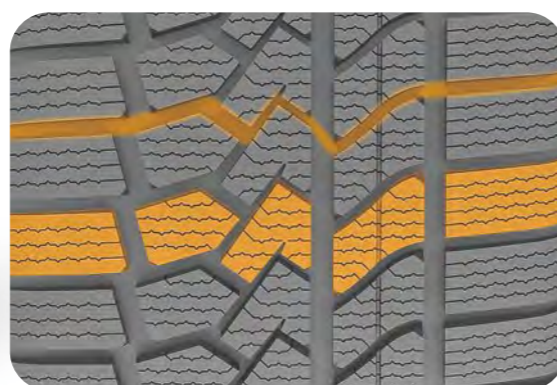

M+S



Rim Size	16 - 20
Series	35 - 70
Speed Rating	H - V

Zuper Snow Z-507

Rim (inch)	Size	LR/PR	Service Index	Standard Rim	Section Width (mm)	Overall Diameter (mm)	Max. Load (kg)	Max. Air Pressure (kpa)	TT/TL
16"	195/45R16XL	-	84V	6.5J	195	582	500	350	TL
	205/45R16XL	-	87V	7.0J	206	590	545	350	TL
	215/45R16	-	90V	7.0J	213	600	600	350	TL
	205/50R16XL	-	91V	6.5J	214	612	615	350	TL
	185/55R16	-	83H	6.0J	194	610	487	300	TL
	205/55R16	-	91V	6.5J	214	632	615	300	TL
	215/55R16XL	-	97H	7.0J	226	642	730	350	TL
	225/55R16XL	-	99V	7.0J	233	654	775	350	TL
	205/60R16	-	92H	6.0J	209	652	630	300	TL
	215/60R16XL	-	99H	6.5J	221	664	775	350	TL
	225/60R16	-	98H	6.5J	228	676	750	300	TL
	235/60R16	-	100H	7.0J	240	688	800	300	TL
	215/65R16	-	98H	6.5J	221	686	750	300	TL
	215/70R16	-	100H	6.5J	221	708	800	300	TL
	235/70R16	-	106H	7.0J	240	736	950	300	TL
	245/70R16	-	107H	7.0J	248	750	975	300	TL
265/70R16	-	112H	8.0J	272	778	1120	300	TL	
17"	215/45R17XL	-	91V	7.0J	213	626	615	350	TL
	225/45R17XL	-	94V	7.5J	225	634	670	350	TL
	235/45R17XL	-	97V	8.0J	236	644	730	350	TL
	245/45R17XL	-	99V	8.0J	243	652	775	350	TL
	205/50R17XL	-	93V	6.5J	214	638	650	350	TL
	215/50R17XL	-	95V	7.0J	226	648	690	350	TL
	225/50R17XL	-	98V	7.0J	233	658	750	350	TL
	205/55R17XL	-	95V	6.5J	214	658	690	350	TL
	215/55R17XL	-	98V	7.0J	226	668	750	350	TL
	225/55R17XL	-	101V	7.0J	233	680	825	350	TL
	235/55R17XL	-	103V	7.5J	245	690	875	350	TL
	215/60R17XL	-	100V	6.5J	221	690	800	350	TL
	225/60R17XL	-	103V	6.5J	228	702	875	350	TL
	235/60R17	-	102V	7.0J	240	714	850	300	TL
	225/65R17	-	102H	6.5J	228	724	850	300	TL
	245/65R17	-	107H	7.0J	248	750	975	300	TL
265/65R17	-	112H	8.0J	272	776	1120	300	TL	
18"	225/40R18XL	-	92V	8.0J	230	637	630	350	TL
	235/40R18XL	-	95V	8.5J	241	645	690	350	TL
	245/40R18XL	-	97V	8.5J	248	653	730	350	TL
	225/40R18XL	-	99V	8.0J	230	661	775	350	TL
18"	215/45R18XL	-	93V	7.0J	213	651	650	350	TL
	225/45R18XL	-	95V	7.5J	225	659	690	350	TL
	235/45R18XL	-	98V	8.0J	236	669	750	350	TL
	245/45R18XL	-	100V	8.0J	243	677	800	350	TL
	255/45R18XL	-	103V	8.5J	255	687	875	350	TL
	215/50R18	-	92V	7.0J	226	673	630	300	TL
	225/50R18XL	-	99V	7.0J	233	683	775	350	TL
	235/50R18XL	-	101V	7.5J	245	693	825	350	TL
	245/50R18XL	-	104V	7.5J	253	703	900	350	TL
	215/55R18XL	-	99V	7.0J	226	693	775	350	TL
	225/55R18XL	-	102V	7.0J	233	705	850	350	TL
	235/55R18XL	-	104V	7.5J	245	715	900	350	TL
	255/55R18XL	-	109V	8.0J	265	737	1030	350	TL
	225/60R18XL	-	104V	6.5J	228	727	900	350	TL
	235/60R18XL	-	107V	7.0J	240	739	975	350	TL
	19"	225/35R19XL	-	88V	8.0J	230	641	560	350
235/35R19XL		-	91V	8.5J	241	647	615	350	TL
255/35R19XL		-	96V	9.0J	260	661	710	350	TL
225/40R19XL		-	93V	8.0J	230	663	650	350	TL
235/40R19XL		-	96V	8.5J	241	671	710	350	TL
245/40R19XL		-	98V	8.5J	248	679	750	350	TL
255/40R19XL		-	100V	9.0J	260	687	800	350	TL
275/40R19XL		-	105V	9.5J	278	703	925	350	TL
225/45R19XL		-	96V	7.5J	225	685	710	350	TL
235/45R19XL		-	99V	8.0J	236	695	775	350	TL
245/45R19XL		-	102V	8.0J	243	703	850	350	TL
255/45R19XL		-	104V	8.5J	255	713	900	350	TL
235/50R19XL		-	103V	7.5J	245	719	875	350	TL
245/50R19XL		-	105H	7.5J	253	729	925	350	TL
255/50R19XL		-	107V	8.0J	265	739	975	350	TL
225/55R19		-	99V	7.0J	233	731	775	300	TL
235/55R19XL	-	105V	7.5J	245	741	925	350	TL	
255/55R19XL	-	111H	8.0J	265	763	1090	350	TL	
20"	275/40R20XL	-	106V	9.5J	278	728	950	350	TL
	255/45R20XL	-	105V	8.5J	255	738	925	350	TL
	275/45R20XL	-	110V	9.0J	273	756	1060	350	TL

Made in China



SW608

SW608



Benefits and Features

- V-shaped tread design works with high-drainage groove to drain snow, slush and water quickly
- Optimized direction of sipes maximize the tyre's contact with the road surface and delivers outstanding traction and control in all winter driving conditions
- Special winter tread compound offers performance driving



M+S



Rim Size	13 - 20
Series	30 - 80
Speed Rating	Q - V

Rim (inch)	Size	LR/PR	Service Index	Standard Rim	Section Width (mm)	Overall Diameter (mm)	Max. Load (kg)	Max. Air Pressure (kpa)	TT/TL	
14"	185R14C	D/8PR	102/100Q	5.5J	188	650	850/800	450	TL	
15"	195/70R15C	D/8PR	104/102R	6.0J	201	655	900/850	450	TL	
13"	155/70R13	-	75T	4.5B	157	548	387	300	TL	
	165/70R13	-	79T	5.0B	170	562	437	300	TL	
	175/70R13	-	82T	5.0B	177	576	475	350	TL	
	155/80R13	-	79T	4.5B	157	578	437	300	TL	
14"	185/60R14	-	82H	5.5J	189	578	475	300	TL	
	195/60R14	-	86H	6.0J	201	590	530	300	TL	
	155/65R14	-	75T	4.5B	157	558	387	300	TL	
	175/65R14	-	82H	5.0J	177	584	475	300	TL	
	185/65R14	-	86H	5.5J	189	596	530	350	TL	
	165/70R14	-	81T	5.0J	170	588	462	300	TL	
	175/70R14	-	84T	5.0J	177	602	500	300	TL	
	185/70R14	-	88T	5.5J	189	616	560	300	TL	
	195/70R14	-	91T	6.0J	201	630	615	300	TL	
15"	185/55R15 XL	-	86H/V	6.0J	194	585	530	350	TL	
	195/55R15 XL	-	89H	6.0J	201	595	580	350	TL	
	185/60R15 XL	-	88H	5.5J	189	603	560	350	TL	
	195/60R15	-	88H	6.0J	201	615	560	300	TL	
	175/65R15	-	84T	5.0J	177	609	500	300	TL	
	185/65R15	-	88H	5.5J	189	621	560	300	TL	
	195/65R15	-	91H	6.0J	201	635	615	300	TL	
	205/65R15	-	94H	6.0J	209	647	670	300	TL	
	215/70R15	-	98H	6.5J	221	683	750	300	TL	
	16"	195/50R16 XL	-	88H	6.0J	201	602	560	350	TL
225/50R16 XL		-	96V	7.0J	233	632	710	350	TL	
195/55R16		-	87H	6.0J	201	620	545	300	TL	
205/55R16		-	91H	6.5J	214	632	615	300	TL	
215/55R16 XL		-	97H	7.0J	226	642	730	350	TL	
225/55R16 XL		-	99H	7.0J	233	654	775	350	TL	
205/60R16		-	92H	6.0J	209	652	630	300	TL	
215/60R16 XL		-	99H	6.5J	221	664	775	350	TL	
225/60R16	-	98H	6.5J	228	676	750	300	TL		
16"	215/65R16	-	98H	6.5J	221	686	750	300	TL	
	17"	205/40R17 XL	-	84V	7.5J	212	596	500	350	TL
		215/40R17 XL	-	87V	7.5J	218	604	545	350	TL
	17"	245/40R17 XL	-	95V	8.5J	248	628	690	350	TL
		205/45R17 XL	-	88V	7.0J	206	616	560	350	TL
		215/45R17 XL	-	91V	7.0J	213	626	615	350	TL
		225/45R17 XL	-	94V	7.5J	225	634	670	350	TL
		235/45R17 XL	-	97H	8.0J	236	644	730	350	TL
		245/45R17 XL	-	99V	8.0J	243	652	775	350	TL
		205/50R17 XL	-	93H	6.5J	214	638	650	350	TL
215/50R17 XL		-	95V	7.0J	226	648	690	350	TL	
225/50R17 XL		-	98H	7.0J	233	658	750	350	TL	
215/55R17 XL		-	98V	7.0J	226	668	750	350	TL	
17"	225/55R17 XL	-	101V	7.0J	233	680	825	350	TL	
	235/55R17 XL	-	103V	7.5J	245	690	875	350	TL	
	215/60R17	-	96H	6.5J	221	690	710	300	TL	
	225/60R17	-	99H	6.5J	228	702	775	300	TL	
	235/65R17 XL	-	108H	7.0J	240	738	1000	350	TL	
	18"	225/40R18 XL	-	92V	8.0J	230	637	630	350	TL
		235/40R18 XL	-	95V	8.5J	241	645	690	350	TL
		245/40R18 XL	-	97V	8.5J	248	653	730	350	TL
		225/45R18 XL	-	95V	7.5J	225	659	690	350	TL
		235/45R18 XL	-	98V	8.0J	236	669	750	350	TL
245/45R18 XL		-	100V	8.0J	243	677	800	350	TL	
225/50R18 XL		-	99V	7.0J	233	683	775	350	TL	
235/50R18 XL		-	101V	7.5J	245	693	825	350	TL	
245/50R18 XL		-	104V	7.5J	253	703	900	350	TL	
225/60R18 XL		-	104V	6.5J	228	727	900	350	TL	
19"	225/35R19 XL	-	88V	8.0J	230	641	560	350	TL	
	235/45R19 XL	-	99V	8.0J	236	695	775	350	TL	
	245/45R19 XL	-	102V	8.0J	243	703	850	350	TL	
	20"	245/30R20 XL	-	90V	8.5J	248	656	600	350	TL

Made in China

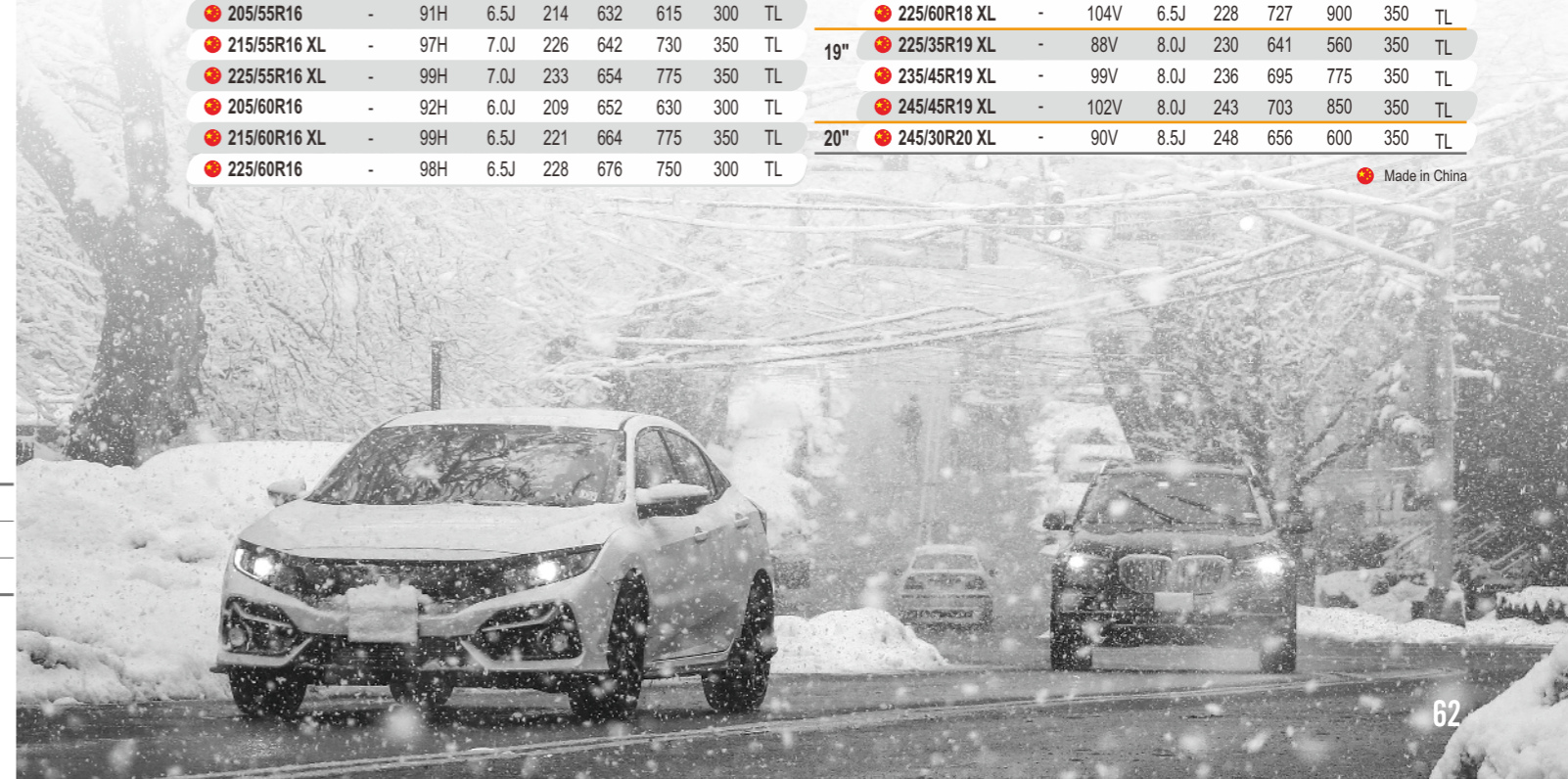

SW628



Benefits and Features

- Asymmetric pattern design provides superior handling on snow surface
- Deeper tread grooves and sipes design helps to maintain a strong traction performance in extreme road condition
- Silica-enhanced tread compound keeps rubber flexible for maximum performance in extreme cold temperatures in winter

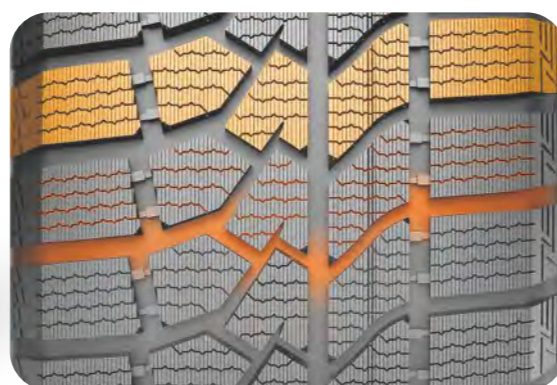

Rim Size	14 - 22
Series	35 - 75
Speed Rating	T - V

SW628

Rim (inch)	Size	LR/PR	Service Index	Standard Rim	Section Width (mm)	Overall Diameter (mm)	Max. Load (kg)	Max. Air Pressure (kpa)	TT/TL
14"	195/60R14	-	86T	6.0J	201	590	530	300	TL
15"	195/50R15	-	82T	6.0J	201	577	475	300	TL
	175/65R15	-	84T	5.0J	177	609	500	300	TL
	215/75R15	-	100T	6.0J	216	703	800	300	TL
	225/75R15	-	102T	6.0J	223	719	850	300	TL
	235/75R15	-	105T	6.5J	235	733	925	300	TL
16"	205/55R16	-	91T	6.5J	214	632	615	300	TL
	215/55R16	-	93T	7.0J	226	642	650	300	TL
	205/60R16	-	92T	6.0J	209	652	630	300	TL
	215/60R16	-	95T	6.5J	221	664	690	300	TL
	235/60R16	-	100H	7.0J	240	688	800	300	TL
	215/70R16	-	100T	6.5J	221	708	800	300	TL
	225/70R16	-	103T	6.5J	228	722	875	300	TL
	235/70R16	-	106T	7.0J	240	736	950	300	TL
	245/70R16	-	107T	7.0J	248	750	975	300	TL
	265/70R16	-	112T	8.0J	272	778	1120	300	TL
17"	225/45R17	-	91H	7.5J	225	634	615	300	TL
	205/50R17 XL	-	93H	6.5J	214	638	650	350	TL
	225/50R17	-	94T	7.0J	233	658	670	300	TL
	205/55R17 XL	-	95H	6.5J	214	658	690	350	TL
	215/55R17	-	94T	7.0J	226	668	670	300	TL
	225/55R17	-	97T	7.0J	233	680	730	300	TL
	235/55R17	-	99H	7.5J	245	690	775	300	TL
	215/60R17	-	96T	6.5J	221	690	710	300	TL
	225/60R17	-	99T	6.5J	228	702	775	300	TL
	255/60R17 XL	-	110T	7.5J	260	738	1060	350	TL
	215/65R17	-	99T	6.5J	221	712	775	300	TL
	225/65R17	-	102T	6.5J	228	724	850	300	TL
	245/65R17	-	107T	7.0J	248	750	975	300	TL
	265/65R17	-	112T	8.0J	272	776	1120	300	TL
	285/65R17	-	116T	8.5J	292	802	1250	300	TL
	245/70R17	-	110T	7.0J	248	776	1060	300	TL
	265/70R17	-	115T	8.0J	272	804	1215	300	TL
18"	225/40R18 XL	-	92H	8.0J	230	637	630	350	TL
	245/40R18 XL	-	97H	8.5J	248	653	730	350	TL
	255/40R18 XL	-	99H	9.0J	260	661	775	350	TL
	215/45R18 XL	-	93V	7.0J	213	651	650	350	TL
	245/45R18 XL	-	100T	8.0J	243	677	800	350	TL
	255/45R18 XL	-	103H	8.5J	255	687	875	350	TL
	215/50R18	-	92H	7.0J	226	673	630	300	TL
	225/50R18 XL	-	99H	7.0J	233	683	775	350	TL
	255/55R18 XL	-	109H	8.0J	265	737	1030	350	TL
	225/60R18 XL	-	104H	6.5J	228	727	900	350	TL
	235/60R18	-	103T	7.0J	240	739	875	300	TL
18"	255/60R18 XL	-	112T	7.5J	260	763	1120	350	TL
	265/60R18 XL	-	114T	8.0J	272	775	1180	350	TL
	285/60R18	-	116T	8.5J	292	799	1250	300	TL
	235/65R18	-	106T	7.0J	240	763	950	300	TL
	265/65R18	-	114T	8.0J	272	801	1180	300	TL
19"	275/35R19 XL	-	100H	9.5J	278	675	800	350	TL
	245/40R19 XL	-	98H	8.5J	248	679	750	350	TL
	255/40R19 XL	-	100H	9.0J	260	687	800	350	TL
	275/40R19 XL	-	105H	9.5J	278	703	925	350	TL
	225/45R19 XL	-	96H	7.5J	225	685	710	350	TL
	245/45R19 XL	-	102H	8.0J	243	703	850	350	TL
	255/45R19 XL	-	104H	8.5J	255	713	900	350	TL
	275/45R19 XL	-	108H	9.0J	273	731	1000	350	TL
	245/50R19 XL	-	105H	7.5J	253	729	925	350	TL
	255/50R19 XL	-	107H	8.0J	265	739	975	350	TL
	265/50R19 XL	-	110H	8.5J	277	749	1060	350	TL
	225/55R19	-	99H	7.0J	233	731	775	300	TL
	245/55R19	-	103H	7.5J	253	753	875	300	TL
	275/55R19	-	111T	8.5J	284	785	1090	300	TL
	235/60R19 XL	-	107T	7.0J	240	765	975	350	TL
	255/60R19 XL	-	113T	7.5J	260	789	1150	350	TL
20"	315/35R20 XL	-	110H	11.0J	320	728	1060	350	TL
	255/40R20 XL	-	101H	9.0J	260	712	825	350	TL
	275/40R20 XL	-	106H	9.5J	278	728	950	350	TL
	285/40R20	-	104H	10.0J	290	736	900	300	TL
	235/45R20 XL	-	100H	8.0J	236	720	800	350	TL
	245/45R20 XL	-	103H	8.0J	243	728	875	350	TL
	255/45R20 XL	-	105H	8.5J	255	738	925	350	TL
	235/50R20 XL	-	104H	7.5J	245	744	900	350	TL
	245/50R20	-	102H	7.5J	253	754	850	300	TL
	265/50R20 XL	-	111H	8.5J	277	774	1090	350	TL
	275/50R20 XL	-	113H	8.5J	284	784	1150	350	TL
	285/50R20 XL	-	116H	9.0J	297	794	1250	350	TL
	235/55R20 XL	-	105H	7.5J	245	766	925	350	TL
	255/55R20 XL	-	110H	8.0J	265	788	1060	350	TL
	275/55R20 XL	-	117H	8.5J	284	810	1285	350	TL
21"	315/35R21 XL	-	111H	11.0J	320	753	1090	350	TL
	295/40R21 XL	-	111H	10.5J	301	769	1090	350	TL
	255/45R21	-	102H	8.5J	255	763	850	300	TL
	265/45R21	-	104H	9.0J	266	771	900	300	TL
	275/45R21 XL	-	110H	9.0J	273	781	1160	350	TL
	275/50R21 XL	-	113H	8.5J	284	809	1150	350	TL
22"	265/40R22 XL	-	106H	9.5J	271	771	950	350	TL

Made in China



SW618



Benefits and Features

- Premium studless winter tyre providing excellent snow, slush and wet traction in cold climates
- Special pattern design to promote aggressive bite in deep snow and wet road conditions
- Superior tread compound keeps rubber flexible for maximum performance in extreme cold temperatures in winter

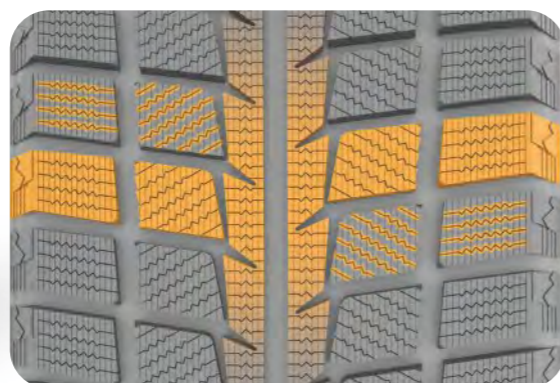

Rim Size	13 - 20
Series	30 - 70
Speed Rating	T - V

SW618

Rim (inch)	Size	LR/PR	Service Index	Standard Rim	Section Width (mm)	Overall Diameter (mm)	Max. Load (kg)	Max. Air Pressure (kpa)	TT/TL	
13"	155/65R13	-	73T	4.5J	157	532	365	300	TL	
	165/65R13	-	77T	5.0J	170	544	412	300	TL	
	165/70R13	-	79T	5.0J	170	562	437	300	TL	
	175/70R13	-	82T	5.0J	177	576	475	300	TL	
14"	165/60R14	-	75T	5.0J	170	554	387	300	TL	
	185/60R14	-	82T	5.5J	189	578	475	300	TL	
	155/65R14	-	75T	4.5B	157	558	387	300	TL	
	175/65R14	-	82T	5.0J	177	584	475	300	TL	
	185/65R14	-	86T	5.5J	189	596	530	300	TL	
	165/70R14	-	81T	5.0J	170	588	462	300	TL	
	175/70R14	-	84T	5.0J	177	602	500	300	TL	
	185/70R14	-	88T	5.5J	189	616	560	300	TL	
15"	195/70R14	-	91T	6.0J	201	630	615	300	TL	
	195/50R15	-	82T	6.0J	201	577	475	300	TL	
	185/55R15	-	82T	6.0J	194	585	475	300	TL	
	195/55R15	-	85H	6.0J	201	595	515	300	TL	
	185/60R15	-	84T	5.5J	189	603	500	300	TL	
	195/60R15	-	88T	6.0J	201	615	560	300	TL	
	185/65R15	-	88T	5.5J	189	621	560	300	TL	
	195/65R15	-	91T	6.0J	201	635	615	300	TL	
	205/65R15	-	94T	6.0J	209	647	670	300	TL	
	205/70R15	-	96T	6.0J	209	669	710	300	TL	
16"	215/70R15	-	98T	6.5J	221	683	750	300	TL	
	195/55R16 XL	-	91V	6.0J	201	620	615	350	TL	
	205/55R16	-	91H	6.5J	214	632	615	300	TL	
	215/55R16	-	93T	7.0J	226	642	650	300	TL	
	225/55R16	-	95T	7.0J	233	654	690	300	TL	
	195/60R16	-	89T	6.0J	201	640	580	300	TL	
	205/60R16	-	92T	6.0J	209	652	630	300	TL	
	215/60R16	-	95T	6.5J	221	664	690	300	TL	
17"	225/60R16	-	98T	6.5J	228	676	750	300	TL	
	205/65R16	-	95T	6.0J	209	672	690	300	TL	
	215/65R16	-	98T	6.5J	221	686	750	300	TL	
	225/65R16	-	100T	6.5J	228	698	800	300	TL	
	215/45R17 XL	-	91V	7.0J	213	626	615	350	TL	
	235/45R17 XL	-	97T	8.0J	236	644	730	350	TL	
	215/50R17 XL	-	95H	7.0J	226	648	690	350	TL	
	225/50R17	-	94T	7.0J	233	658	670	300	TL	
	235/50R17 XL	-	100H	7.5J	245	668	800	350	TL	
	215/55R17	-	94T	7.0J	226	668	670	300	TL	
18"	225/55R17 XL	-	101H	7.0J	233	680	825	350	TL	
	235/55R17	-	99T	7.5J	245	690	775	300	TL	
	225/60R17	-	99T	6.5J	228	702	775	300	TL	
	225/65R17	-	102T	6.5J	228	724	850	300	TL	
	235/65R17	-	104T	7.0J	240	738	900	300	TL	
	235/40R18 XL	-	95V	8.5J	241	645	690	350	TL	
	225/45R18 XL	-	95H	7.5J	225	659	690	350	TL	
	235/45R18 XL	-	98T	8.0J	236	669	750	350	TL	
	245/45R18 XL	-	100T	8.0J	243	677	800	350	TL	
	235/50R18 XL	-	101T	7.5J	245	693	825	350	TL	
19"	245/50R18 XL	-	104T	7.5J	253	703	900	350	TL	
	215/55R18 XL	-	99H	7.0J	226	693	775	350	TL	
	225/55R18	-	98H	7.0J	233	705	750	300	TL	
	235/55R18 XL	-	104T	7.5J	245	715	900	350	TL	
	245/60R18	-	105H	7.0J	248	751	925	300	TL	
	235/50R19	-	99H	7.5J	245	719	775	300	TL	
	235/55R19 XL	-	105H	7.5J	245	741	925	350	TL	
	255/55R19 XL	-	111H	8.0J	265	763	1090	350	TL	
	20"	275/30R20 XL	-	97H	9.5J	278	674	730	350	TL
		275/45R20 XL	-	110H	9.0J	273	756	1060	350	TL
255/50R20 XL		-	109H	8.0J	265	764	1030	350	TL	

Made in China



SW612



Benefits and Features

- All-round winter performance for vans and other commercial vehicles
- Remarkable safety through excellent grip, handling and traction in snow, mud and wet surface
- Comfortable ride and precise handling with long tread life

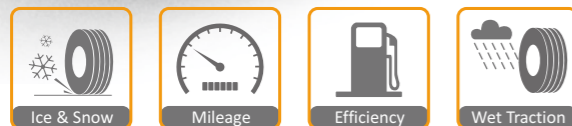
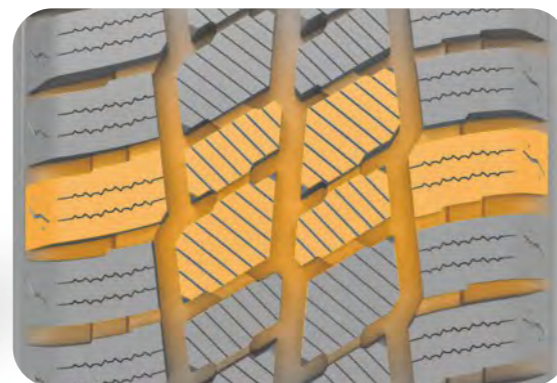

Rim Size	12 - 16
Series	60 - 75
Speed Rating	N - T

SW612

Rim (inch)	Size	LR/PR	Service Index	Standard Rim	Section Width (mm)	Overall Diameter (mm)	Max. Load (kg)	Max. Air Pressure (kpa)	TT/TL
12"	155R12C	D/8PR	88/86Q	4.5B	157	550	560/530	450	TL
	155R13C	C/6PR	85/83Q	4.5J	157	578	515/487	350	TL
	165R13C	C/6PR	91/89Q	4.5B	165	594	615/580	450	TL
13"	175R13C	D/8PR	97/95Q	5.0B	177	610	730/690	450	TL
	185R14C	D/8PR	102/100R	5.5J	188	650	850/800	450	TL
	175/70R14C	C/6PR	95/93Q	5.0J	177	602	690/650	375	TL
14"	195R15C	D/8PR	106/104R	5.5J	196	693	950/900	450	TL
	205/65R15C	C/6PR	102/100T	6.0J	209	647	850/800	375	TL
	195/70R15C	D/8PR	104/102R	6.0J	201	655	900/850	450	TL
15"	205/70R15C	D/8PR	106/104R	6.0J	209	669	950/900	450	TL
	215/70R15C	D/8PR	109/107R	6.5J	221	683	1030/975	450	TL
	225/70R15C	D/8PR	112/110R	6.5J	228	697	1120/1060	450	TL
16"	6.50R16	E/10PR	108/107N	5.5F	185	750	1000/975	560	TL
	7.00R16	F/12PR	117/116N	5.5F	200	775	1258/1250	670	TL
	195/60R16C	C/6PR	99/97T	6.0J	201	640	775/730	375	TL
16"	195/65R16C	D/8PR	104/102T	6.0J	201	660	900/850	475	TL
	205/65R16C	D/8PR	107/105T	6.0J	209	672	975/925	475	TL
	215/65R16C	D/8PR	109/107R	6.5J	221	686	1030/975	475	TL
16"	225/65R16C	D/8PR	112/110R	6.5J	228	698	1120/1060	475	TL
	235/65R16C	D/8PR	115/113R	7.0J	240	712	1215/1150	475	TL
	185/75R16C	D/8PR	104/102Q	5.0J	184	684	900/850	475	TL
16"	195/75R16C	D/8PR	107/105R	5.5J	196	698	975/925	475	TL
	205/75R16C	D/8PR	110/108Q	5.5J	203	714	1060/1000	475	TL
	215/75R16C	D/8PR	113/111Q	6.0J	216	728	1150/1090	475	TL
16"	225/75R16C	E/10PR	118/116Q	6.0J	223	744	1320/1250	525	TL

● Made in China



IceMaster Spike Z-506



Benefits and Features

- Studable V-shaped tread design delivers outstanding traction and braking performance on snow and icy roads
- Stiff shoulder blocks deliver outstanding cornering stability and enhanced grips

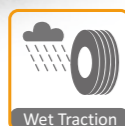
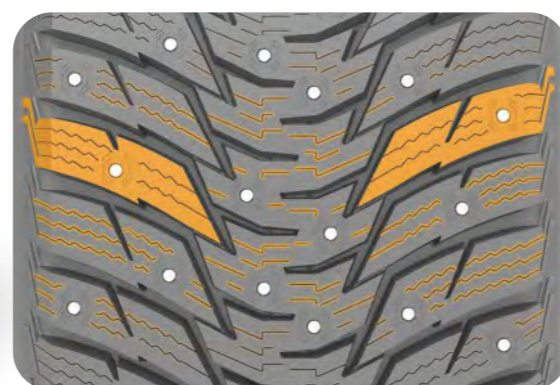

Rim Size	14 - 20
Series	35 - 70
Speed Rating	T - H

IceMaster Spike Z-506

Rim (inch)	Size	LR/PR	Service Index	Standard Rim	Section Width (mm)	Overall Diameter (mm)	Max. Load (kg)	Max. Air Pressure (kpa)	TT/TL
14"	175/65R14 XL	-	86T	5.0J	177	584	530	350	TL
	185/60R14	-	82T	5.5J	189	578	475	320	TL
	185/65R14	-	86T	5.5J	189	596	530	320	TL
	195/70R14 XL	-	91T	6.0J	201	630	615	320	TL
15"	195/60R15	-	88T	6.0J	201	615	560	320	TL
	185/65R15 XL	-	92T	5.5J	189	621	630	350	TL
	195/65R15 XL	-	95T	6.0J	201	635	690	350	TL
	205/65R15	-	94T	6.0J	209	647	670	320	TL
16"	205/50R16	-	87T	6.5J	214	612	545	320	TL
	195/55R16	-	87T	6.0J	201	620	545	320	TL
	205/55R16 XL	-	94T	6.5J	214	632	670	350	TL
	215/55R16 XL	-	97T	7.0J	226	642	730	350	TL
	225/55R16	-	95T	7.0J	233	654	690	320	TL
	205/60R16 XL	-	96T	6.0J	209	652	710	350	TL
	215/60R16	-	95T	6.5J	221	664	690	320	TL
	205/65R16	-	95T	6.0J	209	672	690	320	TL
	215/65R16	-	98T	6.5J	221	686	750	320	TL
	215/70R16	-	100T	6.5J	221	708	800	320	TL
17"	235/70R16	-	106T	7.0J	240	736	950	320	TL
	215/45R17 XL	-	91T	7.0J	213	626	615	350	TL
	225/45R17 XL	-	94H	7.5J	225	634	670	350	TL
	235/45R17 XL	-	97T	8.0J	236	644	730	350	TL
	245/45R17 XL	-	99T	8.0J	243	652	775	350	TL
	205/50R17 XL	-	93T	6.5J	214	638	650	350	TL
	215/50R17 XL	-	95T	7.0J	226	648	690	350	TL
	225/50R17 XL	-	98H	7.0J	233	658	750	350	TL
	215/55R17 XL	-	98T	7.0J	226	668	750	350	TL
	225/55R17 XL	-	101T	7.0J	233	680	825	350	TL
18"	235/55R17	-	99T	7.5J	245	690	775	320	TL
	215/60R17	-	96T	6.5J	221	690	710	320	TL
	225/60R17 XL	-	103T	6.5J	228	702	875	350	TL
	215/65R17 XL	-	103T	6.5J	228	702	875	350	TL
	215/65R17 XL	-	103T	6.5J	228	702	875	350	TL
	215/65R17 XL	-	103T	6.5J	228	702	875	350	TL
	215/65R17 XL	-	103T	6.5J	228	702	875	350	TL
	215/65R17 XL	-	103T	6.5J	228	702	875	350	TL
	215/65R17 XL	-	103T	6.5J	228	702	875	350	TL
	215/65R17 XL	-	103T	6.5J	228	702	875	350	TL
19"	215/65R17 XL	-	103T	6.5J	228	702	875	350	TL
	225/65R17	-	102T	6.5J	228	724	850	320	TL
	235/65R17	-	104T	7.0J	240	738	900	320	TL
	245/65R17 XL	-	111T	7.0J	248	750	1090	350	TL
	265/70R17	-	115T	8.0J	272	804	1250	320	TL
	225/40R18 XL	-	92T	8.0J	230	637	630	350	TL
	235/40R18 XL	-	95T	8.5J	241	645	690	350	TL
	245/40R18 XL	-	97T	8.5J	248	653	730	350	TL
	225/45R18 XL	-	95H	7.5J	225	659	690	350	TL
	235/45R18 XL	-	98T	8.0J	236	669	750	350	TL
20"	245/45R18 XL	-	100T	8.0J	243	677	800	350	TL
	235/50R18 XL	-	101T	7.5J	245	693	825	350	TL
	215/55R18 XL	-	99T	7.0J	226	693	775	350	TL
	225/55R18 XL	-	102T	7.0J	233	705	850	350	TL
	235/55R18 XL	-	104T	7.5J	245	715	900	350	TL
	255/55R18 XL	-	109T	8.0J	265	737	1030	350	TL
	225/60R18 XL	-	104T	6.5J	228	727	900	350	TL
	235/60R18 XL	-	107T	7.0J	240	739	975	350	TL
	255/35R19 XL	-	96T	9.0J	260	661	710	350	TL
	275/35R19 XL	-	100T	9.5J	278	675	800	350	TL
20"	225/40R19 XL	-	93H	8.0J	230	663	630	350	TL
	245/40R19 XL	-	98T	8.5J	248	679	730	350	TL
	245/45R19 XL	-	102T	8.0J	243	703	850	350	TL
	255/45R19 XL	-	104T	8.5J	255	713	900	350	TL
	235/50R19 XL	-	103T	7.5J	245	719	875	350	TL
	255/50R19 XL	-	107T	8.0J	265	739	975	350	TL
	235/55R19	-	105T	7.5J	245	741	925	350	TL
	315/35R20 XL	-	110T	11J	320	728	1060	350	TL
	275/40R20 XL	-	106T	9.5J	278	728	950	350	TL
	275/55R20 XL	-	117T	8.5J	284	810	1285	350	TL
275/60R20	-	115T	8.0J	279	838	1215	320	TL	

Made in China



SW606



Benefits and Features

- Studable V-shaped tread design delivers outstanding traction and braking performance on snow and icy roads
- Stiff shoulder blocks deliver outstanding cornering stability and enhanced grips

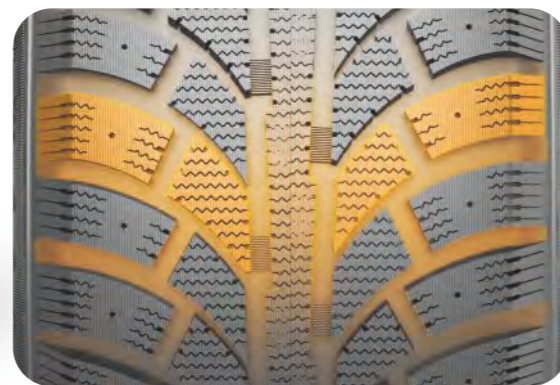

Rim Size	15 - 18
Series	65 - 85
Speed Rating	Q - R

SW606

Rim (inch)	Size	LR/PR	Service Index	Standard Rim	Section Width (mm)	Overall Diameter (mm)	Max. Load (kg)	Max. Air Pressure (kpa)	TT/TL
15"	195/70R15C	D/8PR	104/102R	6.0J	201	655	900/850	450	TL
	225/70R15C	D/8PR	112/110R	6.5J	228	697	1120/1060	450	TL
16"	185/75R16C	D/8PR	104/102R	5.0J	184	684	900/850	475	TL
	LT225/75R16	E/10PR	115/112Q	6.0J	220	739	1215/1120	550	TL
	LT245/75R16	E/10PR	120/116Q	7.0J	245	771	1380/1260	550	TL
	LT265/75R16	E/10PR	123/120Q	7.5J	264	802	1550/1400	550	TL
	LT235/85R16	E/10PR	120/116Q	6.5J	224	801	1380/1260	550	TL
17"	LT245/70R17	E/10PR	119/116Q	7.0J	245	771	1360/1250	550	TL
	LT265/70R17	E/10PR	121/118Q	8.0J	269	799	1450/1320	550	TL
	LT285/70R17	E/10PR	121/118Q	8.5J	288	826	1450/1320	550	TL
	LT245/75R17	E/10PR	121/118Q	7.0J	245	795	1450/1320	550	TL
	LT235/80R17	E/10PR	120/117Q	6.5J	232	802	1400/1285	550	TL
18"	LT275/65R18	E/10PR	123/120Q	8.0J	282	810	1550/1400	550	TL
	LT275/70R18	E/10PR	125/122Q	8.0J	270	837	1650/1500	550	TL

Made in China



TYRE SIZE KNOWLEDGE

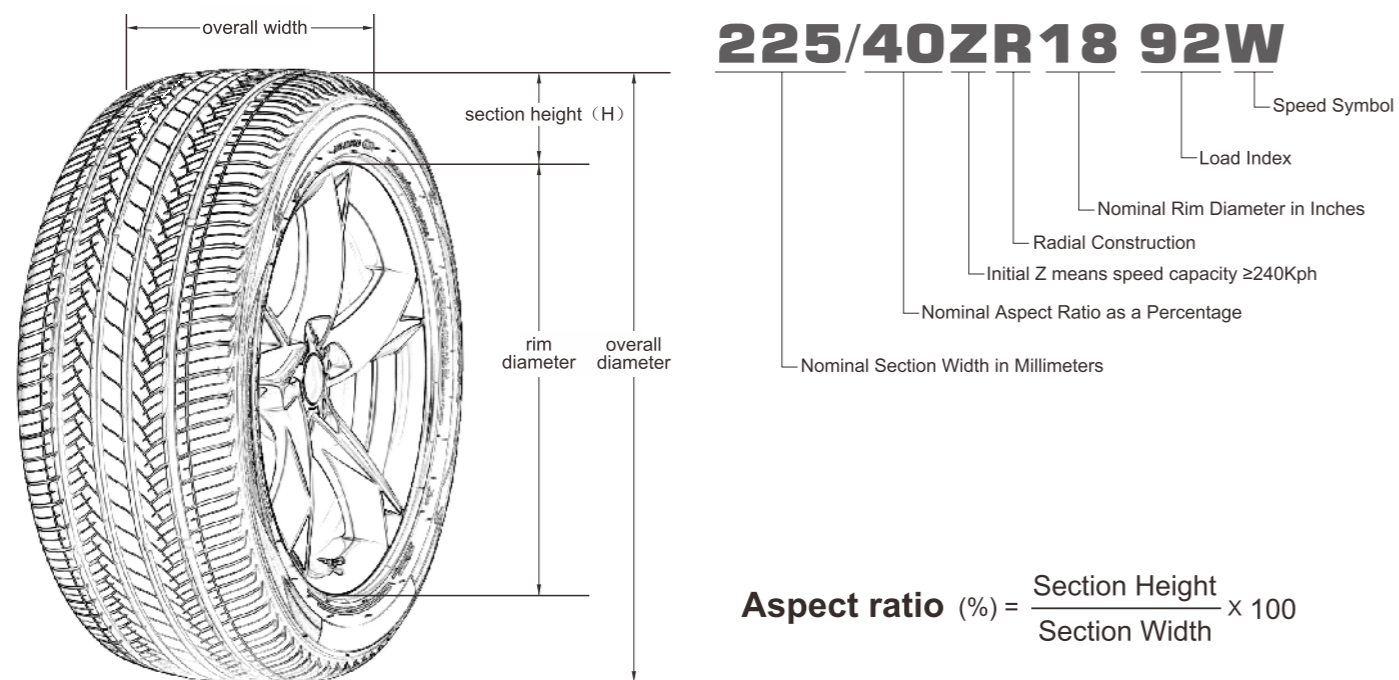

SIDEWALL INSTRUCTION

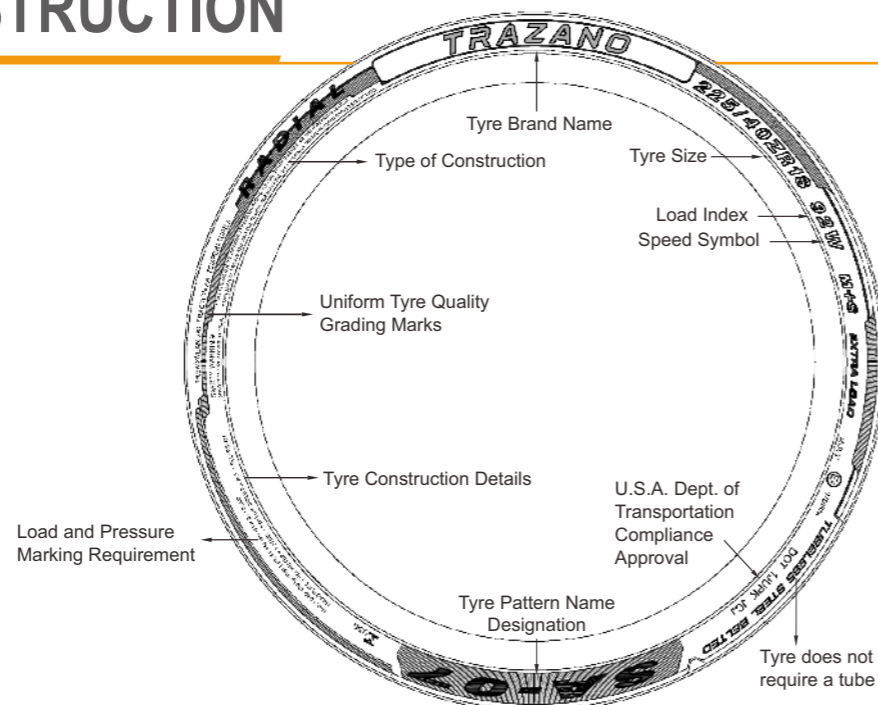

OTHER MARKINGS

- P** as part of the tyre size designation (e.g., P205/65R15) used to indicate tyres intended for services on passenger cars.
- LT** as part of the size designation (e.g., LT235/75R15) used to indicate the tyres are intended for light truck vehicles.
- M&S** letters used to indicate a tyre suitable for Mud and Snow and/or All Season usage.
- XL** as part of the size designation (e.g., P235/75R16 XL) used to indicate the tyre can carry more loads as the maximum inflation pressure and load are greater than a standard load version. (Also could be called REINFORCED or RF).
- ZR** as part of the tyre size designation (e.g. 225/45ZR17 XL) used to indicate the tyre has a maximum speed over 240 kilometer per hour.

TYRE UPGRADE

"Tyre Upgrade" means: increase of rim diameter without changing of tyre overall diameter, the trend in development of low aspect ratio is called upgrade.

INCREASE OF SPORTY PERFORMANCE

The tyre response will be more sensitive when you turn the steering wheel that the flex of tyre will be reduced, and the performance of steering and handling stability will be better, especially under medium and high speed driving.

ENHANCEMENT OF BRAKING ABILITY

The braking stability will be improved due to the decrease of tyre flex when you brake.

Please refer to the clarifications set forth below to upgrade the tyre:

- Without any particular reason, please do not change the overall diameter of tyre easily. The alternation of tyre overall diameter will cause misreading of speedometer or mutual interference between tyre and other parts of vehicle.
- Please determine the width of tyre in accordance with the specific width of vehicle. If the width of the entyre tyre is increased overly, it will cause mutual interference between tyre and other parts of vehicle, even heading out of the tyre from bodywork which will initiate danger.
- Notice the load index of vehicle when you upgrade the tyre. There is rule to the weight which the tyre can bear (load index) for each size. Please refer to the load index when you chose the proper size.

Under the condition of keeping general the same of tyre overall diameter, the tyre can be upgraded to:

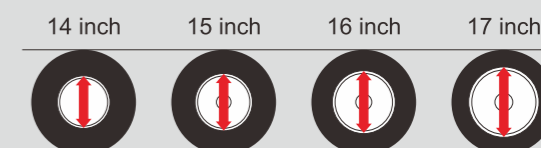

TYRE ROTATION AND INFLATION

TYRE ROTATION

The purpose for rotating tyres is to achieve a more uniform wear for all tyres on a vehicle. Before rotating tyres, determine the cause of any unusual wear and correct any misalignment, imbalance, or other mechanical problems.

Otherwise it will cause: **1.** Ride disturbing; **2.** More noise; **3.** Poor ride comfort; **4.** Shorter of life span.

Note: it is suggested that tyres should be transposed as soon as the phenomena above mentioned are detected (especially the two front wheels).

The tyre transposition patterns are acceptable below. Please refer to your vehicle owner's manual regarding tyre transposition advice.

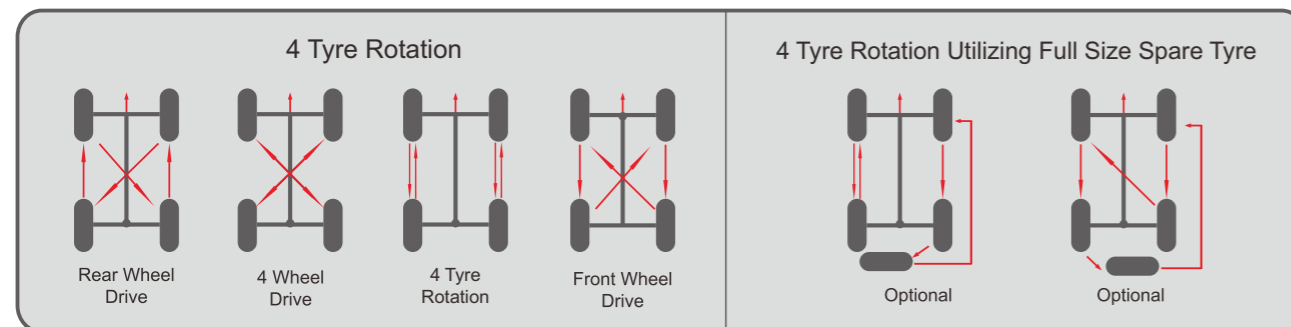

TYRE INFLATION

One of the most important aspects of tyre maintenance is proper inflation.

Sufficient inflation is needed to carry the load and avoid damage. Driving with improper inflation (particularly grossly under inflated or over inflated tyres) is dangerous and can cause critical damage or sudden failure of the tyre(s). Proper inflation should be maintained and check on at least weekly bases and before long distance drives.

Proper inflation should be maintained and checked at least once a week and before a long distance drive.

It is also advisable to take into account axle load and driving conditions when setting inflation pressure. Compensation for heavier loads can be made by increasing inflation pressure, but do not exceed maximum inflation for the tyre or maximum axle load.

In the space of just one month, a tyre can lose 10 pounds of air pressure.

It is important to check your air pressure regularly, to make sure your tyres are neither under nor over inflated.

Under-inflation

Is the worst enemy your tyre can have. It causes increased treadwear on the outside edges (or shoulders)of the tyre. It

also generates excessive heat, which reduces tyre durability. Finally it reduces your fuel economy by increasing rolling resistance-soft tyres make your vehicle work harder.

Over-inflation

Is also detrimental to the tyre. Too much air pressure causes the center of the tread to bear the majority of the truck's weight, which leads to faster deterioration and uneven wear. Any kind of uneven wear will shorten the lifespan of your tyres.

MOUNTING PROCEDURE

There is extreme danger in attempting to install a tyre of one rim diameter on a rim of a different rim diameter.

Always replace a tyre on a rim with another tyre of exactly the same diameter tyre designation and suffix letters.

For example, a 16" tyre goes with a 16" rim. Never mount a 16" size diameter tyre on a 16.5" rim. While it is possible to pass a 16" diameter tyre over the lip or flange of a 16.5" size diameter rim, it cannot be inflated enough to position itself against the rim flange. If an attempt is made to seat the tyre bead by inflating, the tyre bead may break with explosive force and could cause serious bodily injury or death.

Rims of different diameters and tapers cannot be interchanged. The top right diagrams illustrate the difference between rims of two different tapers and diameters.

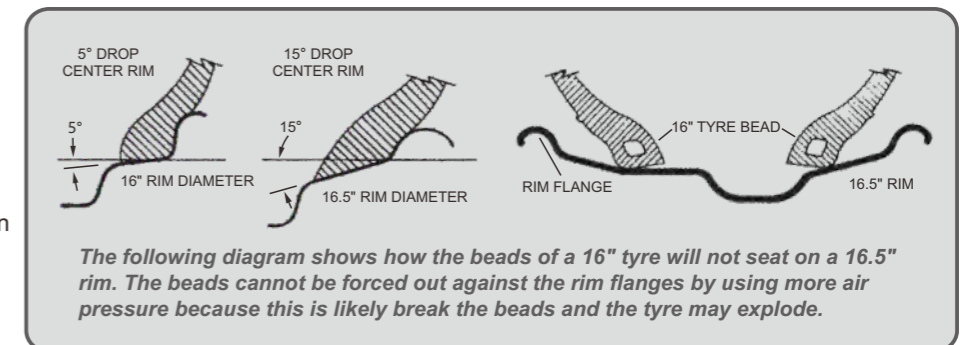

FOR YOUR SAFETY AND COMFORT

Any tyre, no matter how well constructed, may fail in use as a result of punctures, impact damage, improper inflation or other conditions resulting from use.

Tyre failure may create risk of properly damage or personal injury. To reduce the risk of tyre failure and for your safety and comfort, we strongly recommend the following:

- Never mount a tyre on a rim that is damaged or which has been repaired by welding or brazing.

- Never inflate beyond 275 kPa (2.75bar, 40psi) to seat beads.
- Tyre inflation should be done in a safety cage.
- Do not mix different tyre size designations or construction on the same axle, except for limited use of temporary spare tyres.
- Outer diameter of wheel should be the same as inner diameter of tyre.
- Make sure to follow instructions in the car owner's manual or on the vehicle tyre information placard in the car to maintain proper tyre pressure (Particularly driving on highway and/or when carrying heavy loads).
- Never bleed or reduce air pressure when tyres are hot from driving.
- Over- or under-inflation pressure (including spare tyre) at least once a month and before every long trip.
- Stones, gravel and other outer objects stuck in the tyre treads may damage the tyre. Remove outer objects from the tyre treads.
- Tyre should only be mounted by professionally trained persons.
- Objects in the road such as potholes, glass, metal, rocks, wood debris, curbstones and such, which could damage a tyre should be safely avoided.
- To preserve traffic safety and tyre life, ZC rubber recommends driving safely and avoiding hard acceleration, braking or cornering in unnecessary situations.
- If you feel the car is unstable or feel any unusual noises or vibrations, stop your car in safe place and inspect your tyres. Even if no visible defects are found, drive slowly and ask your dealer to inspect your tyres as soon as possible.
- Winter tyres (studless, stud or snow tyres) should not be mixed with other types of tyres.
- New winter tyre should not be driven over 80km/h for the first 100km.
- When driving on winter roads, sudden starts and quick stops should be avoid and a safe car-to-car driving distance should be maintained.
- When using tyre chains be sure to use the proper size chains and affix with priority to the drive axle.
- Avoid driving with tyre chains for long distance on roads with no packed snow or ice.

Never use a tyre under the following conditions and replace tyres immediately:

- If the tread has worn to the tread wear indicator.
- If breaks in the fabric appear.
- If cords or wires are exposed.

Storage of steel belted radial tyres:

- Keep your tyres away from direct sunlight and locations with high temperature, high moisture, heavy electrical machinery, welders etc.
- Tyres should be preferably stored in a cool, dry, and dark room with controlled environment.

To preserve traffic safety, ZC rubber recommends driving substantially slower under adverse weather or road conditions.

ROUTINE MAINTENANCE

- Each month the tyre pressure should be checked one time at least when the tyre is cool, too much or less of the pressure will cause damage to tyre.
- Please take a 15-minutes break after driving on expressway for two hours.
- Please ensure that there are no nails, metal pieces, glass or other foreign materials.
- Please ensure that there is no damage such as separation, distortion and distinct rusting which will cause air leakage.
- Please transpose the tyres regularly (approximately 5000 km) in accordance with abrasion conditions for the sake of expanding its life span and preventing eccentric wear.
- No tyre brightener.

THE INVENTORY OF STEEL-CORD RADIAL TYRE

The tyre should be placed in dry interior.

Note: In order to ensure the driving safety, we suggest that please decrease the speed while driving under atrocious weather and poor terrain condition.

TRAZANO



ZHONGCE RUBBER GROUP CO., LTD.



www.zc-rubber.com



www.facebook.com/zcrubber



www.twitter.com/zc_rubber



www.linkedin.com/company/zcrubber